

**Preprinted version**

Subject to change without prior notice

Switch Actuator Modules for  
the Room Controller

SA/M 2.6.1

ES/M 2.230.1

ES/M 2.24.1

Intelligent Installation Systems



<b>Contents</b>	<b>Page</b>
<b>1 Introduction .....</b>	<b>4</b>
<b>2 Device technology .....</b>	<b>5</b>
2.1 SA/M 2.6.1 Switch Actuator Module, 2-fold, 6 A.....	5
2.1.1 Technical data.....	5
2.1.2 Circuit diagram.....	6
2.1.3 Description of the outputs .....	6
2.1.4 Assembly and installation .....	6
2.2 ES/M 2.230.1 Elect. Switch Actuator Module, 2-fold, 230 V .....	7
2.2.1 Technical data.....	7
2.2.2 Circuit diagram.....	8
2.2.3 Description of the outputs .....	8
2.2.4 Assembly and installation .....	8
2.3 ES/M 2.24.1 Electr. Switch Actuator Module, 2-fold, 24 V .....	9
2.3.1 Technical data.....	9
2.3.2 Circuit diagram.....	10
2.3.3 Description of the outputs .....	10
2.3.4 Assembly and installation .....	10
<b>3 Application and planning.....</b>	<b>11</b>
3.1 The three operating modes.....	11
3.2 Operating mode: "Switch actuator".....	11
3.2.1 Time functions.....	11
3.2.2 Logic.....	13
3.2.3 Presets .....	14
3.2.4 Threshold function .....	15
3.2.5 Function diagram .....	17
3.5 Reaction on voltage failure and recovery .....	17
3.6 Reaction after programming .....	18
<b>4 Project design and programming .....</b>	<b>19</b>
4.1 Overview of the functions .....	19
4.2 General functions.....	19
4.2.1 Parameter window: "A: General" .....	19
4.3 Operating mode: "Switch actuator" .....	20
4.3.1 Overview of the objects.....	20
4.3.2 Parameter window: "A: General" .....	21
4.3.3 Parameter window: "A: Function" .....	22
4.3.4 Parameter window: "A: Time" .....	23
4.3.5 Parameter window: "A: Presets" .....	26
4.3.6 Parameter window: "A: Scene" .....	27
4.3.7 Parameter window: "A: Logic".....	28
4.3.8 Parameter window: "A: Safety".....	28
4.3.9 Parameter window: "A: Threshold" .....	30
4.3.10 Detailed description of the objects.....	31
4.4 Operating mode: "Heating actuator" .....	34
4.4.1 Overview of the objects.....	35
4.4.2 Parameter window: "A: General" .....	36
4.4.3 Parameter window: "A: Function" .....	37

4.4.4	Parameter window: "A: Monitoring" .....	38
4.4.5	Parameter window: "A: Forced operation" .....	38
4.4.6	Parameter window: "A: Valve purge" .....	39
4.4.7	Detailed description of the objects .....	39
4.5	Operating mode: "Fan coil control" .....	42
4.5.1	What is a fan coil unit? .....	42
4.5.2	Overview of the objects .....	42
4.5.3	Parameter window: "A: General" .....	44
4.5.4	Parameter window: "A: Speeds" .....	45
4.5.5	Parameter window: "A: Function" .....	45
4.5.6	Parameter window: "A: Monitoring" .....	46
4.5.7	Parameter window: "A: Speed limitation" .....	46
4.5.8	Parameter window: "A: Forced operation" .....	47
4.5.9	Detailed description of the objects .....	47
<b>5</b>	<b>Appendix.....</b>	<b>50</b>
5.1	Ordering information .....	50

This manual describes the function of the Switch Actuator Module SA/M 2.6.1 and the Electronic Switch Actuator Modules ES/M 2.230.1 and ES/M 2.24.1 for operation in the Room Controller Basis Device.  
Subject to changes and errors excepted.

**Exclusion of liability:**

Despite checking that the contents of this document match the hardware and software, deviations cannot be completely excluded. We therefore cannot accept any liability for this. Any necessary corrections will be inserted in new versions of the manual.

Please inform us of any suggested improvements.

## 1 Introduction

The Switch Actuator Module SA/M 2.6.1 as well as the Electronic Switch Actuator Modules ES/M 2.230.1 and ES/M 2.24.1 are snapped into a module slot of the Room Controller Basis Device RC/A 8.1. They are used to control switched loads such as

- lighting
- electrothermal valve drives
- fan coil units
- signalling equipment

The Room Controller Basis Device establishes the connection to the ABB i-bus<sup>®</sup> EIB / KNX installation bus.

All the modules have two outputs each. The Switch Actuator Module SA/M 2.6.1 switches via relay outputs while the Electronic Switch Actuator Modules switch via noise-free, wear-resistant electronic semiconductor components.

SA/M 2.6.1 and ES/M 2.230.1 are automatically connected to the incoming supply when they are snapped into the Room Controller Basis Device. The ES/M 2.24.1 is supplied via two terminals with 24 V DC.

On the output side, the devices have screw terminals with plug-in connection.

The comprehensive functionality is defined by programming the Room Controller Basis Device with the EIB Tool Software (ETS2 V1.2a or higher). It is almost identical for all three devices.

## 2 Device technology

### 2.1 SA/M 2.6.1 Switch Actuator Module, 2-fold, 6 A

The 2-fold Switch Actuator Module is operated in any module slot of the Room Controller Basis Device. Using relay contacts, it switches two independent groups of electrical loads such as fluorescent lamps. The outputs are distinguished by a high switching current.

Both the incoming supply and the internal voltage are supplied via the Room Controller Basis Device. Contact is automatically established when the modules are snapped in place.

#### 2.1.1 Technical data

<b>Power supply / Incoming supply</b>	– Operating voltage	made available by the Room Controller Basis Device, contact made via contact system on base of module
	– Incoming supply	0...264 V AC, contact established via contact surfaces at the front
<b>Outputs</b>	– 2 load circuits	Relay outputs Max. switching current: 16 A / AC1, 10 A / AC3 Max. continuous current: 6 A Further information: See section 5.1.
	– Contact endurance	10 <sup>7</sup> mechanical 10 <sup>5</sup> electrical (at 230 V / 16 A / AC1)
<b>Connections</b>	– Load circuits	2 x three-pole, plug-in screw terminals
	– Wire ranges	0.2...2.5 mm <sup>2</sup> finely stranded 0.2...40 mm <sup>2</sup> single-core
<b>Ambient temperature range</b>	– Storage	-25 °C ... 55 °C
	– Transport	-25 °C ... 70 °C
<b>Design</b>	– Type of installation	For snapping into the Room Controller Basis Device
	– Housing, colour	Plastic housing, anthracite, halogen-free
	– Housing dimensions (WxHxD)	49 mm x 42 mm x 93 mm
	– Weight	0.1 kg
<b>CE norm</b>	– in accordance with the EMC guideline and the low voltage guideline	

**2.1.2 Circuit diagram**

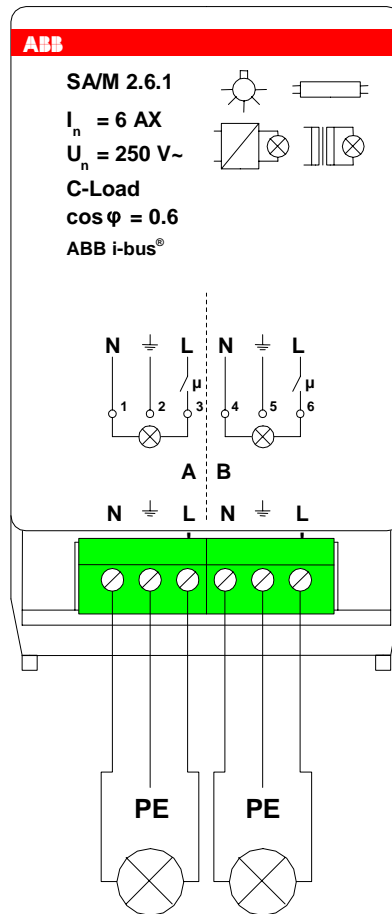

**2.1.3 Description of the outputs**

The device has two relay outputs A and B. The switched incoming supply is applied at output L'. The PE conductor is brought out from the device to connect the protective conductor.

**2.1.4 Assembly and installation**

The device is solely intended for operation in the Room Controller Basis Device. It can be snapped into any module slot. The mounting position can be selected as required.

## 2.2 ES/M 2.230.1 Electr. Switch Actuator Module, 2-fold, 230 V

The 2-fold Electronic Switch Actuator Module is snapped into any module slot of the Room Controller Basis Device. Using two semiconductor outputs, it switches two resistive loads such as electrothermal valve drives for heating control. The outputs are noise-free and wear-resistant. The nominal switching voltage is 115 or 230 V.

Both the incoming supply and the internal voltage are supplied via the Room Controller Basis Device. Contact is automatically established when the modules are snapped in place.

### 2.2.1 Technical data

<b>Power supply / Incoming supply</b>	– Internal supply	made available by the Room Controller Basis Device, contact made via contact system on base of module
	– Incoming supply	90...264 V AC / DC, contact established via contact surfaces at the front
<b>Outputs</b>	– 2 load circuits	Semiconductor outputs for resistive loads Inrush current: max. 1 A Continuous current: max. 700 mA
<b>Connections</b>	– Load circuits	2 x three-pole, plug-in screw terminals
	– Wire ranges	0.2...2.5 mm <sup>2</sup> finely stranded 0.2...4.0 mm <sup>2</sup> single-core
<b>Ambient temperature range</b>	– Storage	-25 °C ... 55 °C
	– Transport	-25 °C ... 70 °C
<b>Design</b>	– Type of installation	For snapping into the Room Controller Basis Device
	– Housing, colour	Plastic housing, anthracite, halogen-free
	– Housing dimensions (WxHxD)	49 mm x 42 mm x 93 mm
	– Weight	0.08 kg
<b>CE norm</b>	– in accordance with the EMC guideline and the low voltage guideline	

### 2.2.2 Circuit diagram

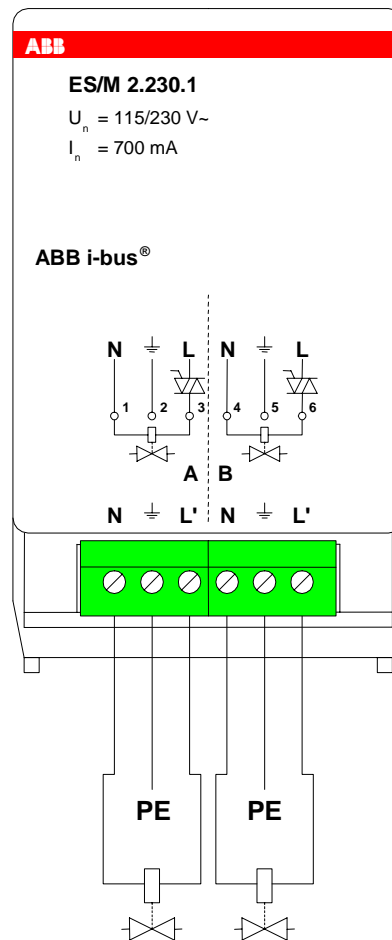

### 2.2.3 Description of the outputs

The device has two semiconductor outputs A and B. The switched incoming supply is applied at output L'. The PE conductor is brought out from the device to connect the protective conductor.

### 2.2.4 Assembly and installation

The device is solely intended for operation in the Room Controller Basis Device. It can be snapped into any module slot. The mounting position can be selected as required.



## 2.3 ES/M 2.24.1 Electr. Switch Actuator Module, 2-fold, 24 V

The 2-fold Electronic Switch Actuator Module is snapped into any module slot of the Room Controller Basis Device. Using two semiconductor outputs, it switches two resistive loads such as electrothermal valve drives for heating control. The outputs are noise-free and wear-resistant. The nominal switching voltage is 12 or 24 V.

Both the incoming supply and the internal voltage are supplied via the Room Controller Basis Device. Contact is automatically established when the modules are snapped in place.

### 2.3.1 Technical data

<b>Power supply / Incoming supply</b>	– Internal supply	made available by the Room Controller Basis Device, contact made via contact system on base of module
	– Incoming supply	10...30 V AC / DC
<b>Outputs</b>	– 2 load circuits	Semiconductor outputs for resistive loads Inrush current: max. 1 A Continuous current: max. 700 mA
<b>Connections</b>	– Load circuits	1 x four-pole, plug-in screw terminal
	– Incoming supply	1 x two-pole, plug-in screw terminal each for connection and for looping through
	– Wire ranges	0.2...2.5 mm <sup>2</sup> finely stranded 0.2...4.0 mm <sup>2</sup> single-core
<b>Ambient temperature range</b>	– Storage	-25 °C ... 55 °C
	– Transport	-25 °C ... 70 °C
<b>Design</b>	– Type of installation	For snapping into the Room Controller Basis Device
	– Housing, colour	Plastic housing, anthracite, halogen-free
	– Housing dimensions (WxHxD)	49 mm x 42 mm x 93 mm
	– Weight	0.08 kg
<b>CE norm</b>	– in accordance with the EMC guideline and the low voltage guideline	

**2.3.2 Circuit diagram**

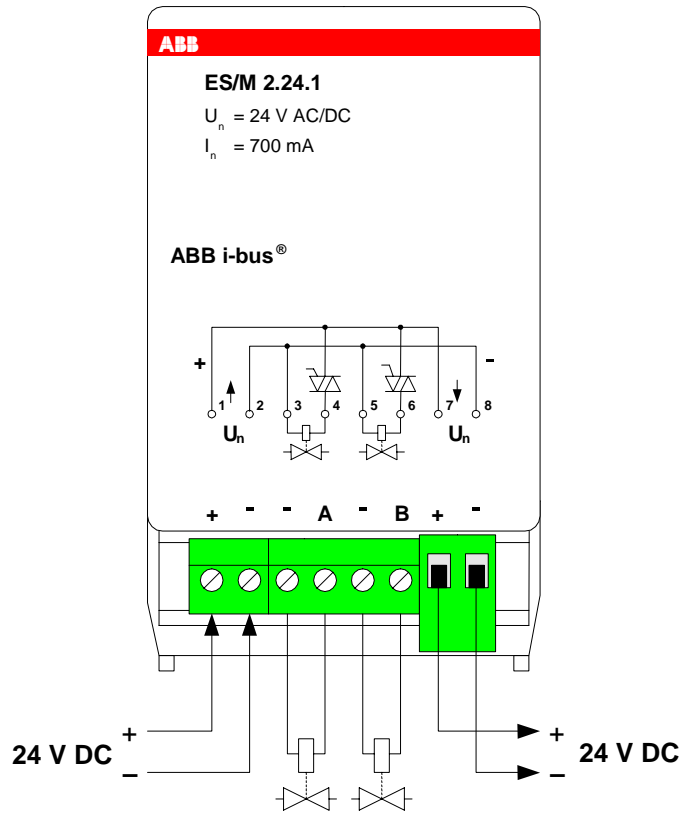

**2.3.3 Description of the outputs**

The output has two switched semiconductor outputs A and B. The incoming supply is fed or looped through to the next module via terminals “+” and “-”.

**2.3.4 Assembly and installation**

The device is solely intended for operation in the Room Controller Basis Device. It can be snapped into any module slot. The mounting position can be selected as required.

### 3 Application and planning

#### 3.1 The three operating modes

It is possible to choose between three operating modes for each output:

1. **Switch actuator**

This function is used for normal switching e.g. of lighting. The output is controlled directly via the object "Telegr. switch". A large number of additional functions are possible.

2. **Heating actuator**

In this function, the output is used to control heating valves e.g. in an individual room temperature control system. A room thermostat sends a control value which the output uses to control the valve (e.g. as PWM or 2-step control).

3. **Fan coil control**

This function is used to control a fan coil unit for air conditioning in a room e.g. in an individual room temperature control system. The control value of the room thermostat controls the fan speed and the valve position of the fan coil unit. Several outputs are required for control and the output therefore controls further outputs ("Slaves") as a "Master" via the bus. The output itself controls fan speed 1.

#### 3.2 Operating mode: "Switch actuator"

##### 3.2.1 Time functions

##### Staircase lighting function

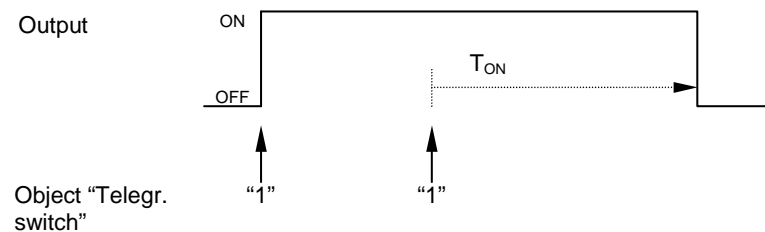

Once the staircase lighting time  $T_{ON}$  has elapsed, the output automatically switches off again. With each "1" telegram, the time restarts ("retrigger function").

A **warning function** enables the user to be warned in good time before the staircase lighting time elapses. The warning can be carried out by switching the output on/off briefly or by sending an object.

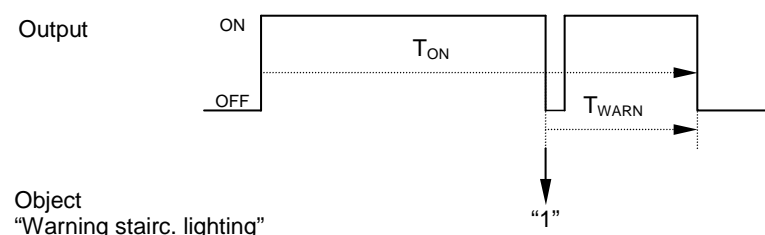

The output is switched off briefly for the period " $T_{WARN}$ " before the staircase lighting time " $T_{ON}$ " elapses and the object "Warning stairc. lighting" is sent. Push button LEDs for example can flash to indicate a warning.

With **pumping**, the user can adapt the staircase lighting time to the current requirements by pressing the push button several times in succession. The maximum duration of the staircase lighting time can be set in the parameters.

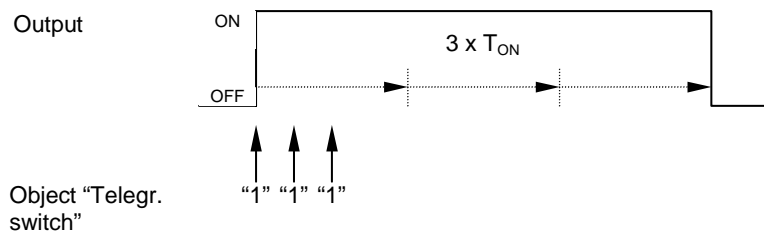

If the device receives a further ON command when the staircase lighting is switched on, the staircase lighting time is added to the remaining period.

Application: Lighting control on staircases, monitoring of telegrams

#### ON/OFF delay

The ON/OFF delay causes the output to be switched on or off with a delay.

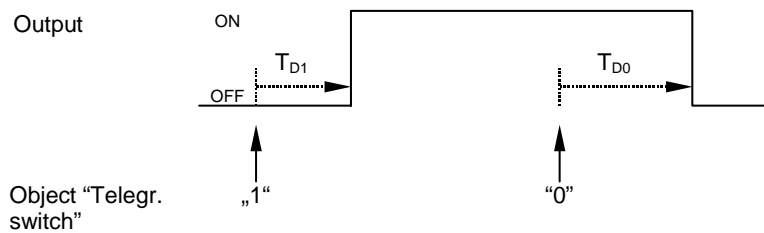

After a switching command, the delay period  $T_{D1}$  or  $T_{D0}$  starts. Once it has elapsed, the output carries out the switching command.

Note: If the device receives an OFF command during the ON delay period  $T_{D1}$ , the ON command is rejected.

Application: e.g. dynamic lightscene, in which luminaires are connected in sequence

#### Flashing

The output can flash by switching on and off periodically.

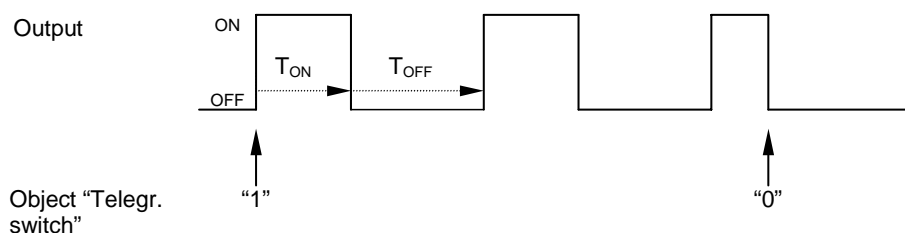

The ON time ( $T_{ON}$ ) and OFF time ( $T_{OFF}$ ) during the flashing can be parameterised.

Note: Please note that the maximum number of switching operations is limited for the Switch Actuator Module SA/M 2.6.1. The number of switching operations is unlimited for the Electronic Switch Actuator Module.

### 3.2.2 Logic

With the “Logic” function, it is possible to link the switching of the output with certain conditions. Two logic objects are available:

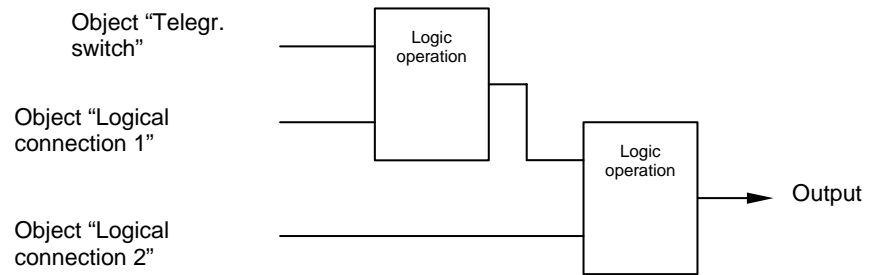

First, the object “Telegr. switch” is evaluated together with the object “Logical connection 1”. The result is linked with the object “Logical connection 2”.

The following logic functions are possible:

Logic function	Object values		Result	Explanation
	Telegr. switch	Logical connection		
AND	0	0	0	The result is 1 if both input values are 1.
	0	1	0	
	1	0	0	
	1	1	1	
OR	0	0	0	The result is 1 if one of the two input values is 1.
	0	1	1	
	1	0	1	
	1	1	1	
XOR	0	0	0	The result is 1 if both input values have a different value.
	0	1	1	
	1	0	1	
	1	1	0	
Gate function	0	0	-	The object “Telegr. switch” is only let through if the gate is open. Otherwise the receipt of the object “Telegr. switch” is ignored. <i>Example shown here: Disable if “OFF (0)”</i>
	0	1	0	
	1	0	-	
	1	1	1	

The logic function is recalculated each time an object value is received.

Example: The gate function is parameterised with “Disable if OFF (0)”.  
 The logic object has the value “0”.  
 The object “Telegr. switch” receives the value “1”  
 → no reaction.  
 Logic object receives the value “1”  
 → the value “1” of object “Telegr. switch” is let through and the output is immediately switched on.

Application: Disable the switching of the lighting.  
 Only switch the lighting on under certain conditions.

### 3.2.3 Presets

A parameterisable switching state can be retrieved with the help of presets. Lightscenes can therefore be implemented for example.

#### Retrieve preset

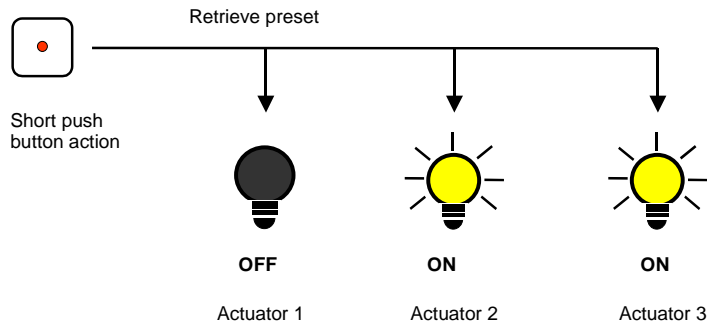

Switching states (“preset values”) can be retrieved via the object “Call preset ...”. A maximum of 4 preset values are available for each output:

Retrieve preset1	Object “Call preset 1/2” = 0
Retrieve preset2	Object “Call preset 1/2” = 1
Retrieve preset3	Object “Call preset 3/4” = 0
Retrieve preset4	Object “Call preset 3/4” = 1

#### Store preset

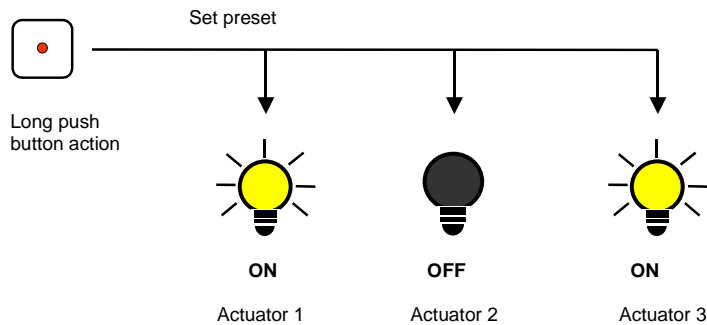

The current switching state is stored as a new preset value via the object “Set preset ...”. The user can thus adapt a lightscene for example. The presets are stored via the following values:

Store preset1	Object “Set preset 1/2” = 0
Store preset2	Object “Set preset 1/2” = 1
Store preset3	Object “Set preset 3/4” = 0
Store preset4	Object “Set preset 3/4” = 1

**Special function: Restore state**

A useful special function can also be assigned to preset1 and preset3, which is used to recreate the brightness level which was present before retrieving preset2 or preset4. The following diagram clarifies this:

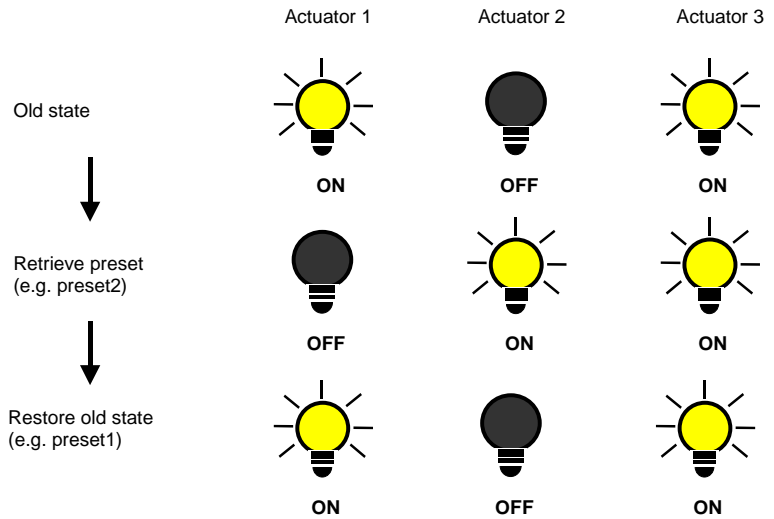

This function can be used for example after a presentation to restore the lighting to the state it was in beforehand.

**3.2.4 Threshold function**

The threshold function monitors a 1-byte or 2-byte value. As soon as this value exceeds or falls below a threshold value, the output can be switched. The threshold values can be interpreted as hysteresis values:

**Threshold values are hysteresis values**

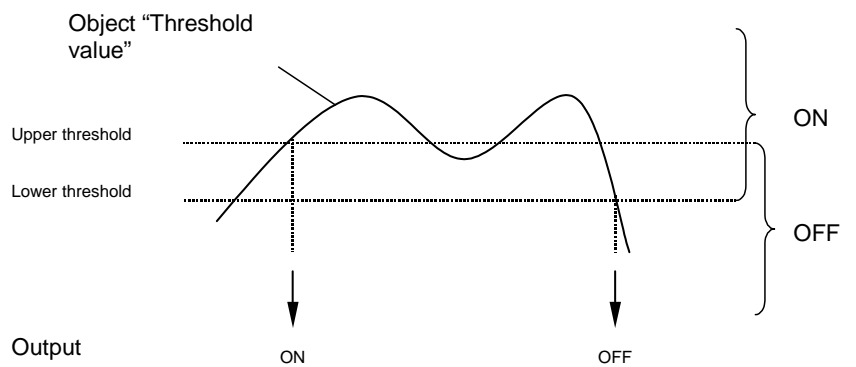

When the value exceeds the upper threshold or falls below the lower threshold, the output is switched.

**Threshold values are not hysteresis values**

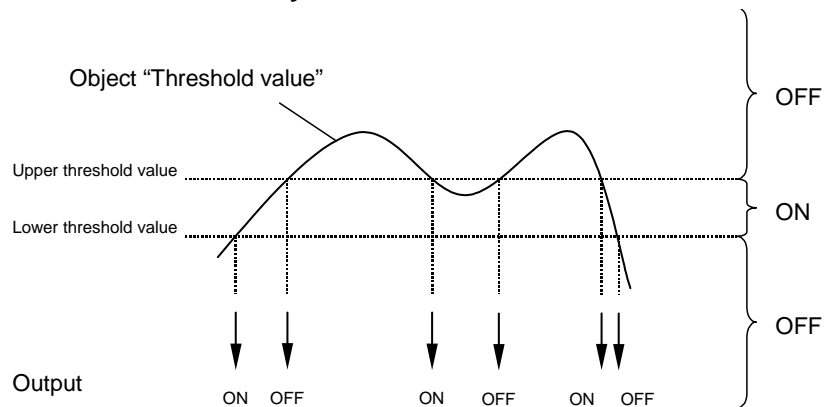

When the value exceeds or falls below any threshold value, the output is switched.

Note: If the object "Threshold value" receives a value which does not exceed or fall below any of the threshold values compared to the old value, no switching operations are triggered.



### 3.2.5 Function diagram

The following diagram shows in which order the functions are processed:

**Command input:**

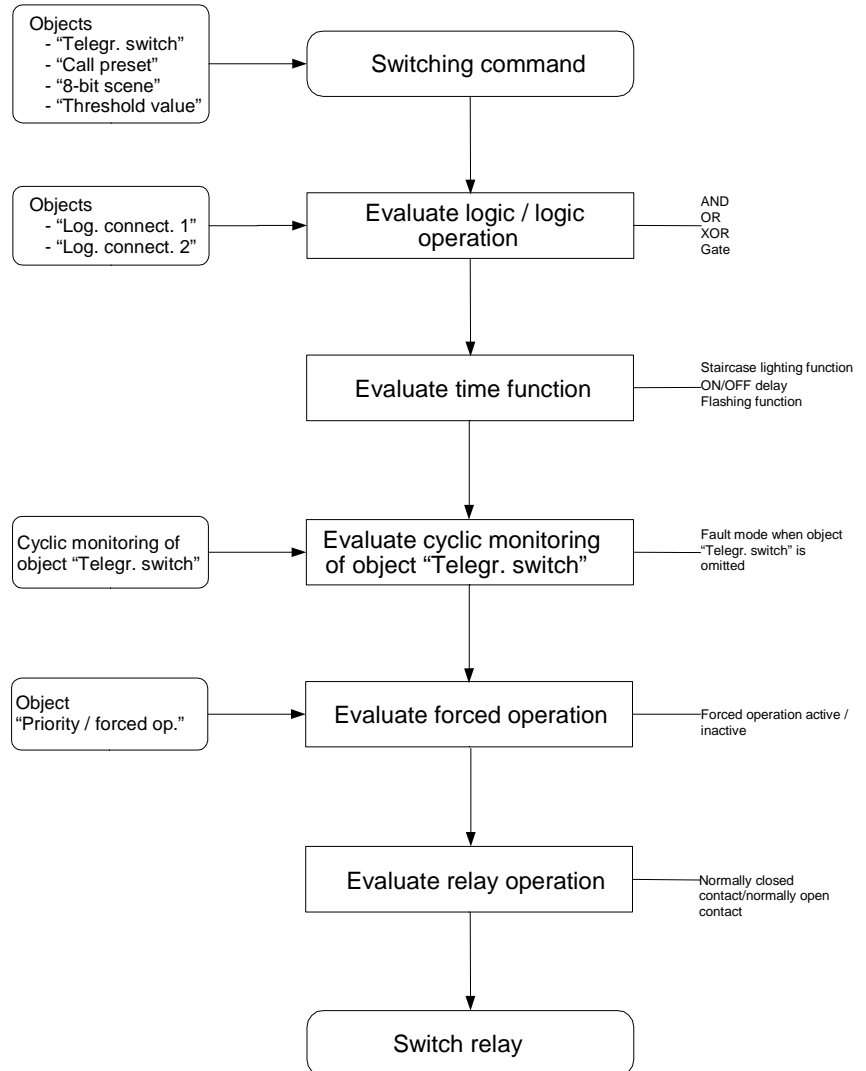

**Example:** On receipt of a "Logical connection" object, the linking logic is evaluated first of all. The result is analysed by the time function; when the staircase lighting function is active, this can result in the staircase lighting being switched on.

The forced operation has the highest priority in the sequence as it is evaluated last of all the functions.

### 3.5 Reaction on voltage failure and recovery

#### Reaction on bus voltage failure

It is possible to parameterise the behaviour of the outputs on failure of the bus voltage. The function of the Room Controller is retained provided that the supply voltage (115 / 230 V AC or 12 V DC auxiliary voltage) is available.

If it has been set in the parameters, the Room Controller can continue to function normally on failure of the bus voltage and the functions in the room are maintained.

In the "Heating actuator" operating mode, any neutral position of the valve can be triggered. In the "Fan coil control" operating mode, the master and slave outputs are switched off (high-resistance). Fan speed 0 is thus triggered.

**Example:** Conventional push buttons are connected to a Room Controller via binary input modules. The Room Controller controls the lighting in the room. On bus voltage failure, the lighting can still be operated because the Room Controller is not supplied by the bus.

#### **Reaction on bus voltage recovery**

The behaviour of the outputs can be parameterised. In the master "Fan coil control" function, the outputs remain switched off until a new control value is received.

#### **Reaction on supply voltage failure**

The supply voltage has failed if both the 115/230 V AC supply and the 12 V DC auxiliary supply have failed. The Room Controller has no function in this case.

For the *Switch Actuator Module SA/M 2.6.1*, the status of the relay outputs can be parameterised so that a defined state can be established. The setting is carried out in the parameter "Reaction on bus voltage failure".

In the "Heating actuator" operating mode, it can be set whether the valve should be fully open or closed during the supply voltage failure. In the "Fan coil control" operating mode, the master and slave outputs are opened. Fan speed 0 is thus triggered.

For the *Electronic Switch Actuator Modules ES/M 2.230.1 and ES/M 2.24.1*, the outputs always switch off during the supply voltage failure (high-resistance).

**Note:** Some stored preset and scene values are lost on failure of the supply voltage. They are overwritten by the parameterised default values.

#### **Reaction on supply voltage recovery**

The behaviour of the outputs is identical to the behaviour on recovery of the bus voltage. It can be parameterised for each output (except for fan coil control).

### **3.6 Reaction after programming**

After programming, the device behaves in the same way as after bus voltage recovery (parameterisable).

ABB i-bus® EIB / KNX	Switch Actuator Module SA/M 2.6.1	2CDG 110 002 R0011
	Electr. Switch Actuator Module ES/M 2.230.1	2CDG 110 013 R0011
	Electr. Switch Actuator Module ES/M 2.24.1	2CDG 110 014 R0011

## 4 Project design and programming

### 4.1 Overview of the functions

The Room Controller has a single application program “Room Controller modular, 8f/1” which is used to set the device function. The programming requires the EIB Tool Software ETS2 **V1.3a** or higher.

Application program	Number of communication objects	Max. number of group addresses	Max. number of associations
Room Controller modular, 8f/1	246	254	254

### 4.2 General functions

#### 4.2.1 Parameter window: “A: General”

The operating mode of the output is set in the first parameter.

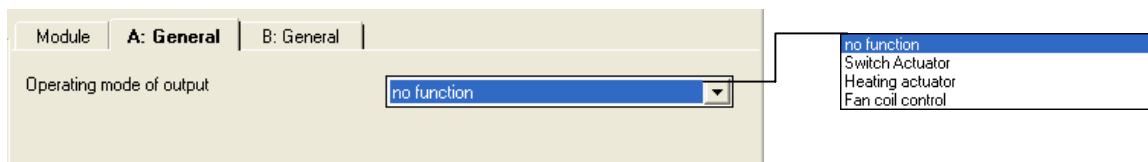

#### Parameter: “Operating mode of output”

The function of the output can be selected here. The options available are “Switch actuator”, “Heating actuator” and “Fan coil control”.

The other parameters are dependent on the selected operating mode.

See under section 3.1 for further explanations about the operating modes.

### 4.3 Operating mode: "Switch actuator"

#### 4.3.1 Overview of the objects

##### General objects

No	Function	Object name	Data type	Flags
0/15	Telegr. switch	Output A	1 Bit (EIS 1)	CW
Switches the output on and off.				
1/16	Status switch	Output A	1 Bit (EIS 1)	CRT
This object reports the current state of the output.				
29	Telegr. status byte	Output A..B	1 Byte (EIS14)	CRT
This object provides further information about the operating state of the device (only Electronic Switch Actuator Modules ES/M 2.230.1 and ES/M 2.24.1).				

##### Additional function "Time, staircase lighting, flashing"

No	Function	Object name	Data type	Flags
2/17	Permanent ON	Output A	1 Bit (EIS1)	CW
For continuous activation of the output in the staircase lighting function.				
3/18	Warning stairc. lighting	Output A	1 Bit (EIS1)	CT
Used to issue a warning before the staircase lighting time elapses.				
4/19	Duration of staircase lighting	Output A	2 Byte (EIS10)	CRW
Changes the duration of the staircase lighting (in seconds).				

##### Additional function "Preset"

No	Function	Object name	Data type	Flags
5/20 7/22	Call preset 1/2 and Call preset 3/4	Output A	1 Bit (EIS1)	CW
Retrieves a parameterised output state. "0" retrieves preset1 or preset3 "1" retrieves preset2 or preset4				
6/21 8/23	Set preset 1/2 and Set preset 3/4	Output A	1 Bit (EIS1)	CW
Stores the current switching state of the output as a new preset value. "0" stores preset1 or preset3 "1" stores preset2 or preset4				

##### Additional function "Scene (8-bit)"

No	Function	Object name	Data type	Flags
9/24	8-bit scene	Output A	1 Byte (non EIS)	CW
Integrates the actuator in a scene. The object value contains a scene number as well as the instruction as to whether a scene should be retrieved or the current output state should be stored as a new scene value.				

**Additional function “Logic”**

No	Function	Object name	Data type	Flags
10/25 11/26	Logical connection 1 <i>and</i> Logical connection 2	Output A	1 Bit (EIS1)	CW
For logic operation of the object “Telegr. switch”. The logic function can be parameterised.				

**Additional function “Priority/forced operation, cyclic monitoring”**

No	Function	Object name	Data type	Flags
12/27	Priority / forced operation	Output A	1 Bit (EIS1) <i>or</i> 2 Bit (EIS8)	CW
Sets the output to a defined state and disables it. Once the forced operation has finished, the output reverts to the state that would have been set without forced operation.				

**Additional function “Threshold value”**

No	Function	Object name	Data type	Flags
13/28	Threshold value	Output A	1 Byte (EIS6) <i>or</i> 2 Byte (EIS5)	CW
If the object value exceeds a parameterisable threshold value, a switching operation can be executed.				

**4.3.2 Parameter window: “A: General”**

General settings can be carried out in this parameter window such as the reaction during/after bus voltage failure and the status response function.

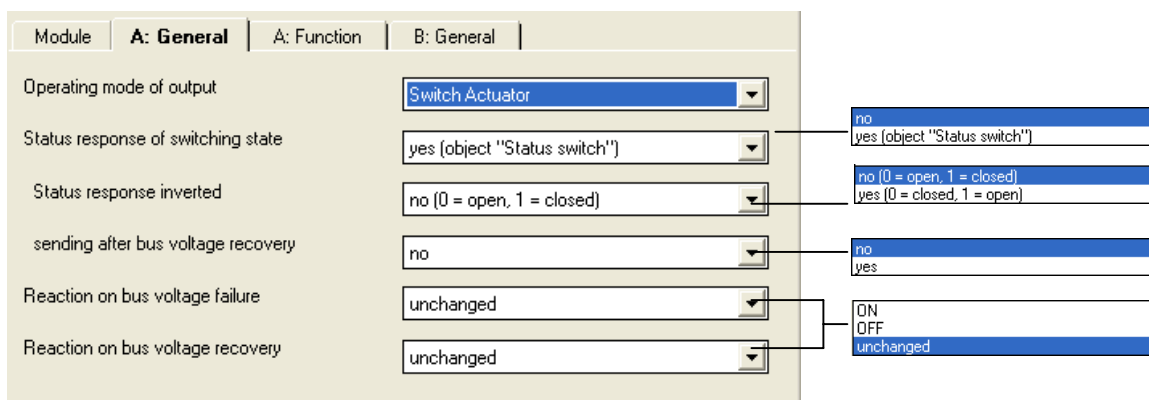

**Parameter: “Status response of switching state”**

The object “Status switch” is enabled with this parameter. It is used to indicate the current switching state on the bus.

**Parameter: “Status response inverted”**

This parameter is visible if the “*Status response of switching state*” is carried out. If “yes” is entered here, the status response object sends a “1” when the relay contact is open and a “0” when the relay contact is closed. This can be advisable for example when the output is operated as a normally closed contact so that the telegram value “1” is received as a status response after an ON command.

**Parameter: “Sending after bus voltage recovery”**

This parameter is visible if the “*Status response of switching state*” is carried out. It can be set whether the switching state is updated on the bus after a bus voltage recovery. The update is carried out in connection with the transmission delay of the Room Controller.

**Parameter: “Reaction on bus voltage failure”**

The output can adopt a defined state on bus voltage failure via this parameter.

It can be set in the parameter whether the output switches “ON” or “OFF”. The contact position can also remain unchanged in the setting “unchanged” (internal function is retained). In this case, the output can still be operated e.g. via push buttons which are connected to binary inputs of the same device.

**Parameter: “Reaction on bus voltage recovery”**

With this parameter, the output can be switched “ON” or “OFF” on recovery of the bus voltage. In the setting “unchanged”, the state of the output does not change.

On bus voltage recovery, the output is set once the parameterised initialisation time of the Room Controller has elapsed.

Note: This parameter can be overwritten by the parameters which are enabled in the “A: Function” parameter window.

**4.3.3 Parameter window: “A: Function”**

Basic settings for the function of an output are carried out in this parameter window. Additional functions can also be enabled.

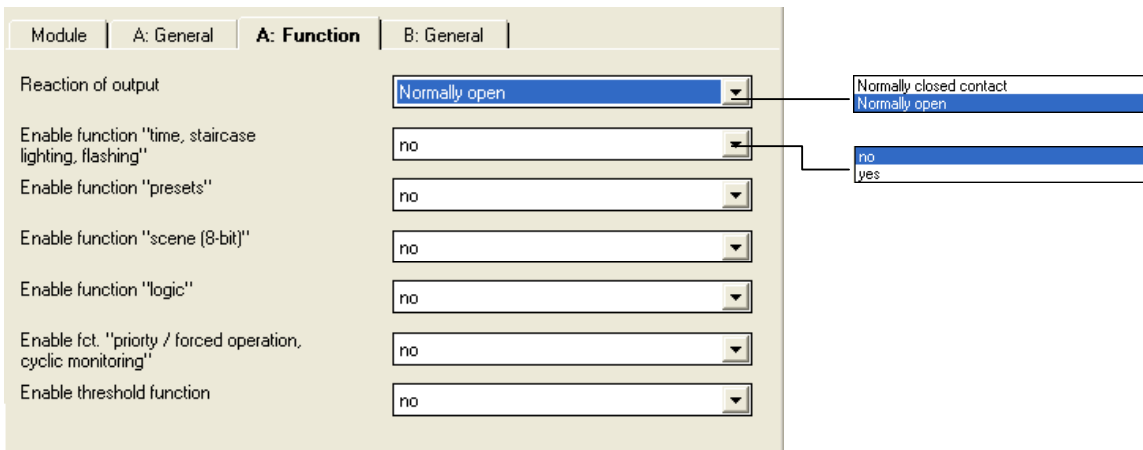

**Parameter: “Reaction of output”**

It can be set in this parameter whether the output operates as a “Normally closed contact” or “Normally open contact”.

In the “Normally open contact” function, an ON command leads to the closing of a contact while an OFF contact causes the contact to be opened. When “Normally closed contact” is selected, the reverse process is carried out.

**Parameter: “Enable function ‘time, staircase lighting, flashing’”**

This parameter enables the function “Time, staircase lighting, flashing” (parameter window “A: Time”).

**Parameter: “Enable function ‘presets’”**

This parameter enables the “Preset” function (parameter window “A: Presets”).

**Parameter: “Enable function ‘scene: (8-bit)’”**

The object “8-bit scene” is enabled via this parameter (parameter window “A: Scene”).

**Parameter: “Enable function ‘logic’”**

This parameter enables the function “Logical connection, disable function” (parameter window “A: Logic”).

**Parameter: “Enable function ‘priority/forced operation, cyclic monitoring’”**

This parameter enables the safety functions “Cyclic monitoring, forced operation” (parameter window “A: Safety”).

**Parameter: “Enable threshold function”**

This parameter enables the ‘Threshold value function” (parameter window “A: Threshold”).

**4.3.4 Parameter window: “A: Time”**

The time functions such as the staircase lighting function, ON/OFF delay and flashing can be set here. The parameter window is enabled under “A: Function”.

Explanations about the time functions can be found in section 3.2.1. Please note the function diagram in section 3.2.5.

**Parameter: “Time function”**

This parameter defines the type of the time function. It is possible to choose between three types: “Staircase lighting”, “ON/OFF delay” and “Flashing”.

**Selection: “Staircase lighting function”**

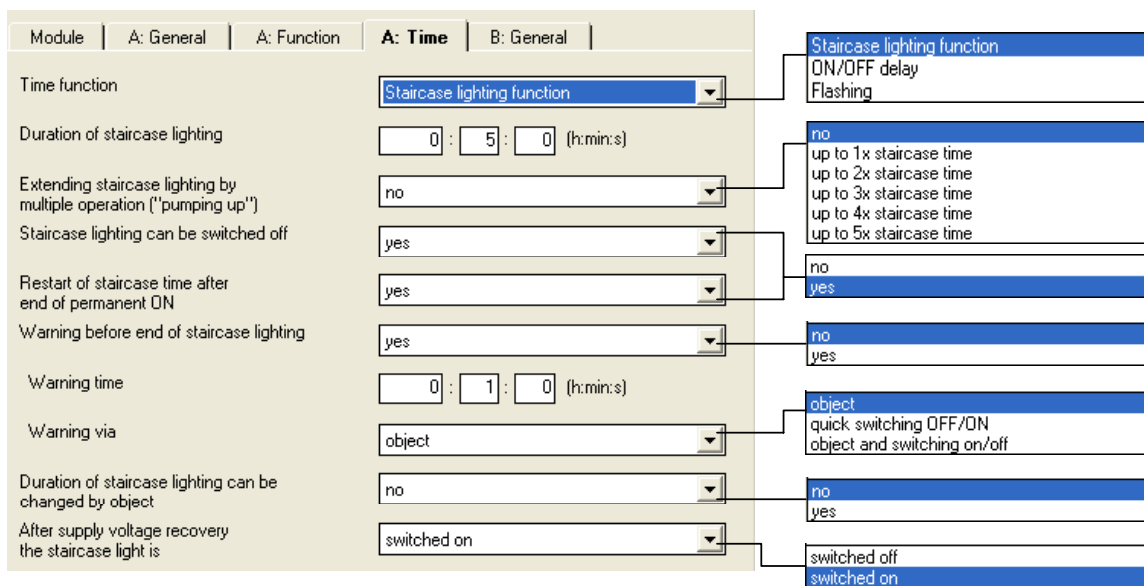

The staircase lighting is switched on via an ON telegram. The staircase lighting time is started when the function is activated. It is switched off when the staircase lighting time elapses.

**Parameter: “Duration of staircase lighting”**

The operating time defines how long the staircase lighting is switched on after an ON command.

**Parameter: “Extending staircase lighting by multiple operation (‘pumping up’)”**

If a further ON telegram is received during the staircase lighting time, the remaining staircase lighting time can be extended by a further period. The maximum period can be set in this parameter.

In the setting “no”, the staircase lighting is reset on receipt of an ON telegram (“retrigger function”).

**Parameter: “Staircase lighting can be switched off”**

It can be set here whether the staircase lighting is switched off prematurely by an OFF telegram (“yes”) or whether the OFF telegram is ignored during the staircase lighting time (“no”).

Note: If the parameter value is “yes”, the staircase lighting can also be switched off via the following other objects, if they lead to a disconnection: “Logical connection”, “Preset”, “Lightscene”, “Disable”, “Permanent ON”, “Forced operation”.

**Parameter: “Reset of staircase time after end of permanent ON”**

This parameter defines how the output is set on receipt of the telegram value “0” at the object “Permanent ON”. The output can switch off immediately (“no”) or remain switched on for the duration of the staircase lighting time.

**Parameter: “Warning before end of staircase lighting”**

The user can be warned before the staircase lighting time elapses for the duration of the “Warning time”. The warning time is contained in the staircase lighting time.

There are two possibilities for issuing a warning: The first one involves setting the object “Warning stairc. lighting” to “1”. The other option switches the output off and on again very briefly. Both possibilities can be set together or separately.

**Parameter: “Warning time”**

The above warning time is set in this parameter.

**Parameter: “Duration of staircase lighting can be changed by object”**

The object “Duration of staircase lighting” is enabled via this parameter. It enables the staircase lighting time to be modified via the bus.

**Parameter: “After supply voltage recovery, the staircase light is”**

It can be set here whether the staircase lighting is “switched on” or “switched off” on recovery of the bus voltage or the supply voltage of the Room Controller. If the option “switched on” is selected, the staircase lighting time restarts after bus voltage recovery.



**Selection “ON/OFF delay”**

It is possible to define in this parameter window whether the output switches on or off with a delay.

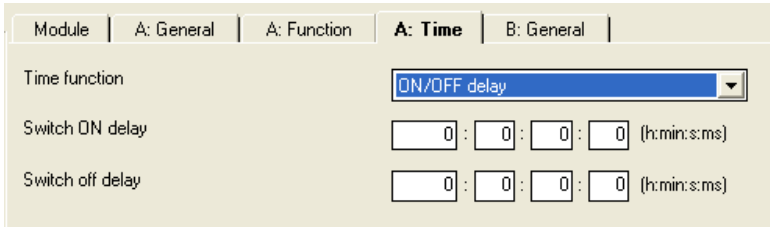

**Parameter: “Switch ON delay”**

This parameter sets the delay for switching on the output after an ON command.

**Parameter: “Switch OFF delay”**

This parameter sets the delay for switching off the output after an OFF command.

**Selection “Flashing”**

When the flashing function is activated, the output starts to flash as soon as the object “Telegr. switch” receives the corresponding value. The flashing rate can be set in the parameters (“Time for ON” or “Time for OFF”). At the start of the flash rate, the output is always switched on. On receipt of a new value at the object “Telegr. switch”, the flashing rate starts from the beginning (except if the flashing has stopped).

As soon as the flashing stops, the output switches off immediately. The flashing can be inverted whereby the output is operated as a “Normally closed contact”.

**Note:** If the status response “Status switch” is active, it also indicates the current state of the relay during the flashing. With a rapid flashing rate, this can lead to a high bus load.

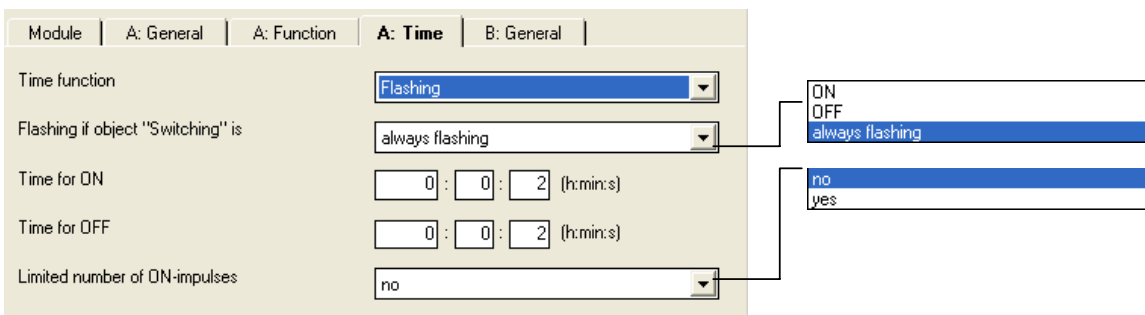

**Parameter: “Flashing if object ‘Switching’ is”**

This parameter sets which value of the object “Telegr. switch” causes the output to flash. It can also be set that the output always flashes.

**Parameter: “Time for ON” or “Time for OFF”**

This parameter defines how long the output is switched on or off during a flashing rate. The smallest value each time is a second; a rapid flashing rate is not advisable due to the maximum switching frequency of the relay (contact endurance).

**Parameter: “Limited number of ON impulses”**

The number of flashing pulses can be limited here. The output is permanently switched off once it has been switched on and off at an adjustable frequency (“**Number of ON impulses**”).

**4.3.5 Parameter window: “A: Presets”**

The preset function is used to retrieve a parameterised value e.g. in order to implement lightscenes. In addition, the output value that is currently set can be saved as a new preset value. The parameter window is enabled under “A: Function”.

There are two objects available for retrieving and storing presets. The parameters for the objects “... preset 1/2” and “... preset 3/4” are identical; the objects “... preset 1/2” are described in the following section by way of example.

Explanations about the preset function can be found in section 3.2.3. Please note the function diagram in section 3.2.5.

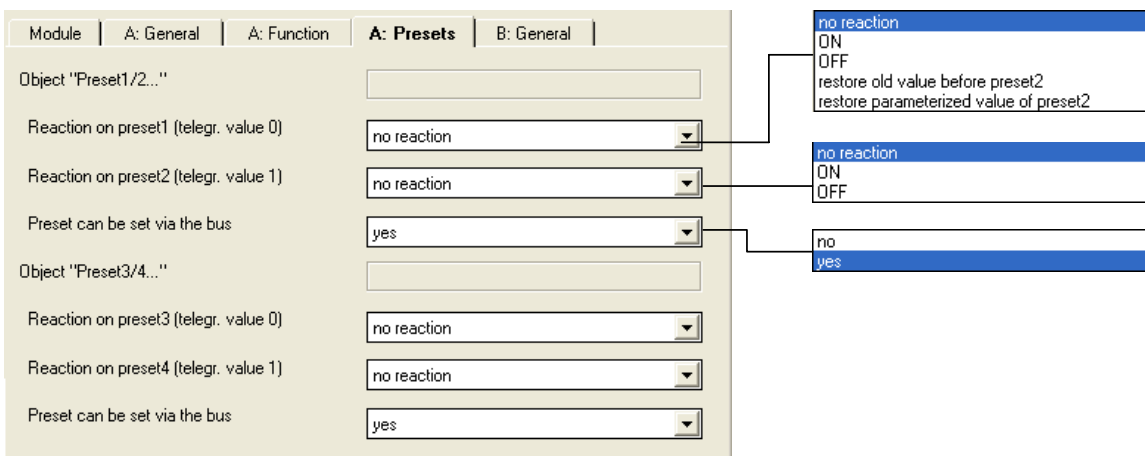

**Parameter: “Reaction on preset1 (telegr. value 0)”**

Preset1 is retrieved if the object “Call preset 1/2” receives the telegram value “0”. In this case, the output can trigger a defined state (“ON”, “OFF” or “no reaction”).

One of the following functions can also be selected.

“*restore old value before preset2*” recreates the state before the last retrieval of preset2.

**Example:** With preset2, the lighting in a conference room is retrieved for a presentation. When the presentation is finished, the lighting is restored via preset1 to the state it was in beforehand.

“*restore parameterised value of preset2*” resets preset2 to the parameterised value. This can be advisable if the preset can be stored via the bus (see below).

**Parameter: “Reaction on preset2 (telegr. value 1)”**

This parameter sets which contact position is selected if the object “Call preset ...” receives the telegram value “1”.

**Parameter: “Preset can be set via the bus”**

The object “Set preset 1/2” is enabled via this parameter (parameter value “yes”). It is used to store the current contact position as a preset value.

Telegram value “0” saves preset1 while telegram value “1” stores preset2.

If the special function “restore old value before preset2” or “restore parameterised value of preset2” has been assigned to preset1, the telegram value “0” is ignored.

**4.3.6 Parameter window: “A: Scene”**

In the 8-bit scene, a push button sends a scene number which causes the actuator to trigger a defined output state. The parameter window is enabled under “A: Function”.

Please note the function diagram in section 3.2.5.

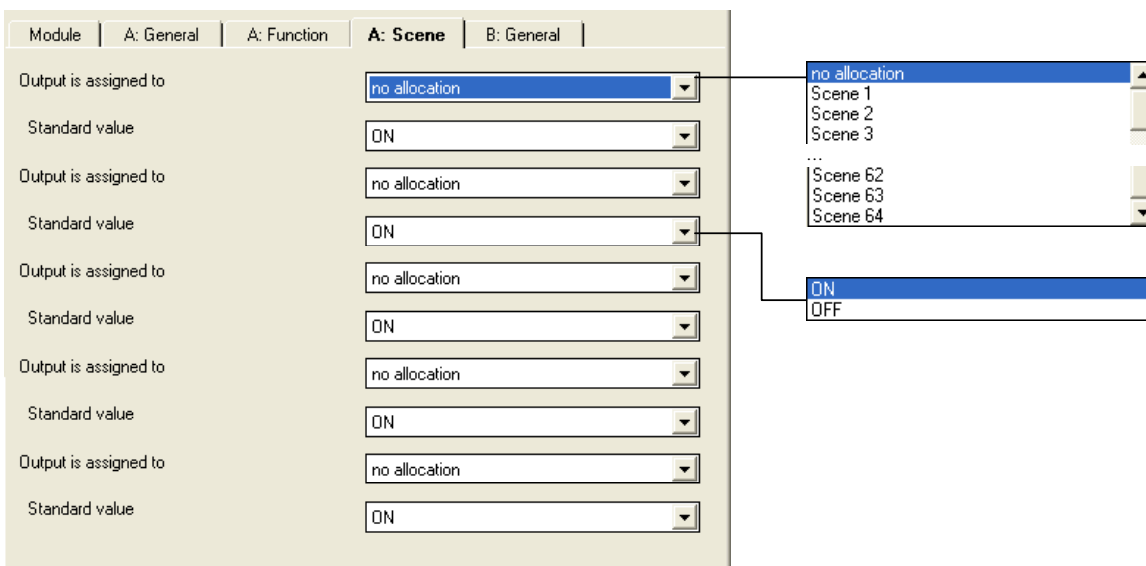

**Parameter: “Output is assigned to”**

Max. 64 different scenes (1...64) can be addressed via a group address. The output can be assigned to a maximum of 5 of them.

**Parameter: “Standard value”**

This parameter sets which state the output adopts when the scene is retrieved.

By storing a scene, the user has the possibility of modifying the value that is parameterised here. After programming or after a supply voltage failure, the value that is parameterised here is restored.

- Note:
- When a scene is retrieved
  - the time functions are restarted
  - the logic operations are re-evaluated

#### 4.3.7 Parameter window: “A: Logic”

The logic function makes up to two logic objects available for each output. These objects are logically linked with the object “Telegr. switch”. The parameter window is enabled under “A: Function”.

The logic function is always recalculated on receipt of an object value. The object “Logical connection 1” is first evaluated together with the object “Telegr. switch”. The result is then linked with object “Logical connection 2”.

The parameters are identical for both logic objects. The function is described in the following section using the example of object “Logical connection 1”.

Explanations about the logic function can be found in section 3.2.2. Please note the function diagram in section 3.2.5.

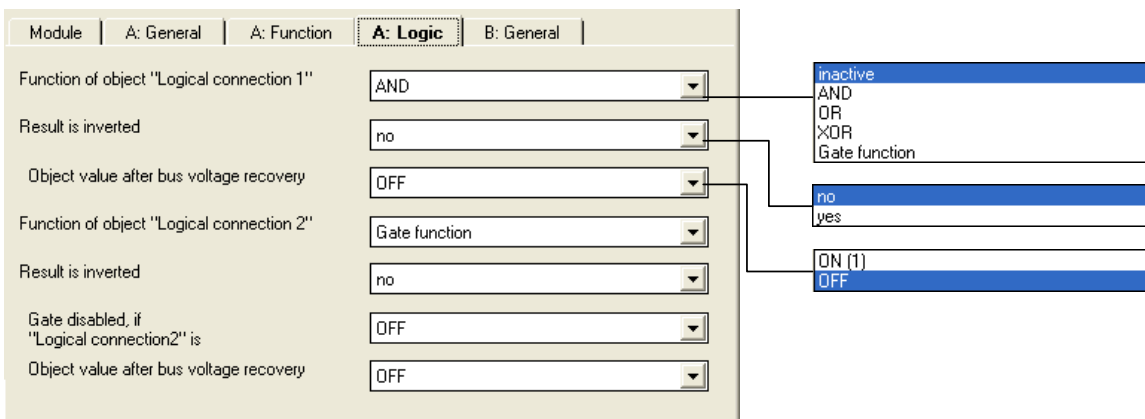

##### Parameter: “Function of object ‘Logical connection ...’”

The logic function of the object “Logical connection ...” is defined here. All three standard operators are possible (AND, OR, XOR). The gate function is also available which can block switching commands.

##### Parameter: “Result is inverted”

The result of the logic operation can be inverted via this parameter: If the logic result is “0”, it is converted into a “1” (and vice versa).

##### Parameter: “Gate disabled, if ‘Logical connection ...’ is”

This parameter is visible if the “Gate function” has been selected. It defines at which object value the gate is disabled i.e. telegrams to the object “Telegr. switch” are ignored.

##### Parameter: “Object value after bus voltage recovery”

This parameter defines which value is assigned to the object “Logical connection 1” or “Logical connection 2” on bus voltage recovery.

#### 4.3.8 Parameter window: “A: Safety”

The safety functions enable a forced operation and the cyclical monitoring of the object “Telegr. switch”. The parameter window is enabled under “A: Function”.

The forced operation sets the output to a defined state which cannot be modified while the forced operation is active. Only the reaction on bus voltage failure/recovery has a higher priority.

The forced operation can take place via a 1-bit or 2-bit object. When using the 2-bit object, the output state is defined via the object value. At the end of the forced operation, the output always follows the state of the switch object.

When using the 1-bit forced operation, the output state is fixed. The reaction at the end of the forced operation can likewise be parameterised.

Please note the function diagram in section 3.2.5.

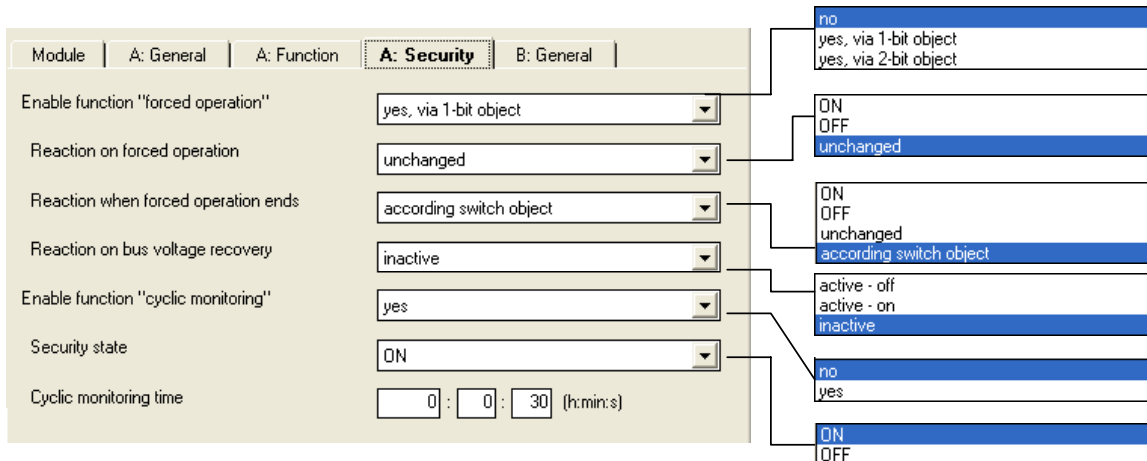

**Parameter: “Enable function ‘forced operation’”**

The forced operation function can be enabled via this parameter. It can be carried out via a 1-bit or 2-bit object.

**Parameter: “Reaction on forced operation”**

This parameter sets which state the output adopts during a forced operation. It is only visible for 1-bit forced operation.

**Parameter: “Reaction when forced operation ends”**

This parameter is visible if forced operation is carried out via a 1-bit object. The state of the relay at the end of the forced operation is defined here. The output can open, close, follow the switch object or remain unchanged.

**Parameter: “Reaction on bus voltage recovery”**

It can be set here whether forced operation is active or inactive after bus voltage recovery. If forced operation is active, the status of the output can be defined. If forced operation is inactive, the output normally follows the settings in the “General” parameter window.

**Parameter: “Enable function ‘cyclic monitoring’”**

The cyclic monitoring of the object “Telegr. switch” can be enabled here. If the device does not receive any telegrams via the object “Telegr. switch” for an adjustable period, the output is set to the safety position. The telegram value can be “0” or “1”.

This function is advisable if the sensor sends the object “Telegr. switch” cyclically on the bus. It is recommended that the monitoring period is set slightly higher than three times the transmission cycle time.

**Parameter: “Cyclic monitoring time”**

The monitoring time with which the object “Telegr. switch” is observed is set here.

**Parameter: “Safety position”**

The state which the relay adopts while the safety position is active is set here. The safety position is automatically cancelled as soon as the device receives a telegram at the object “Telegr. switch” again.

**4.3.9 Parameter window: “A: Threshold”**

The threshold function enables the evaluation of a 1-byte or 2-byte object. As soon as the object value falls below or exceeds a threshold value, a switching operation can be triggered. Up to two independent threshold values are available in total. The parameter window is enabled under “A: Function”.

Explanations about the threshold value function can be found in section 3.2.4. Please note the function diagram in section 3.2.5.

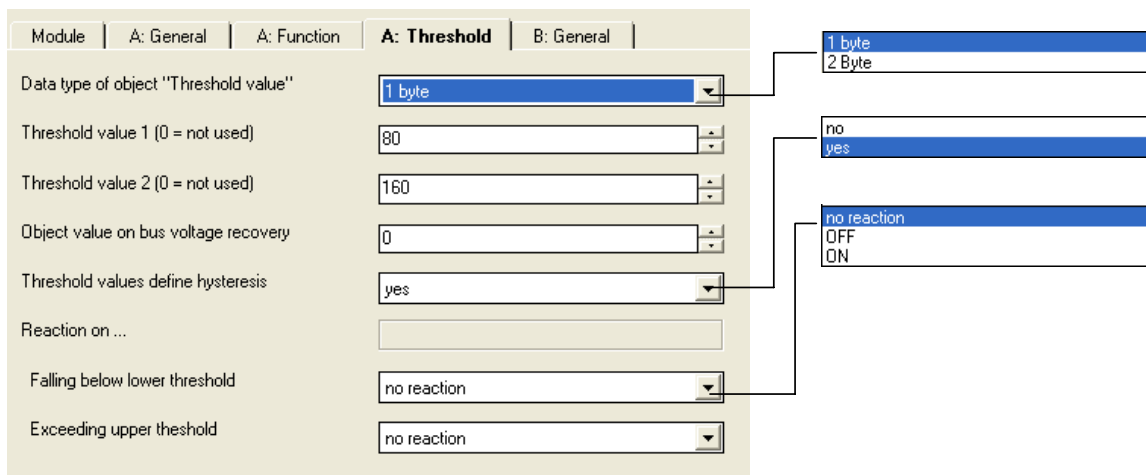

**Parameter: “Data type of object ‘Threshold value’”**

The data type of the object “Threshold value” can be defined here. It is possible to choose between a 1-byte integer value and a 2-byte floating point value.

**Parameter: “Threshold value 1” and “Threshold value 2”**

Two threshold values can be defined here. If they are not required, it is possible to enter zero here. The value range is dependent on the data type.

**Parameter: “Object value on bus voltage recovery”**

The value of the object “Threshold value” after bus voltage recovery can be defined here.

Note: When a threshold value is exceeded  
 - the time functions are restarted  
 - the logic operations are re-evaluated

**Parameter: “Threshold values define hysteresis”**

This parameter defines whether the 1st and 2nd threshold values should be interpreted as hysteresis limits. The hysteresis can reduce unwanted violations of the threshold value if the input value fluctuates around one of the threshold values.

**Parameter: “Object value < lower threshold”**

**Parameter: “Lower thrsh. <= object < upper thrsh.”**

**Parameter: “Object value >= upper threshold”**

These parameters are visible if the threshold values are not hysteresis limits. They define the reaction dependent on the threshold value.

The possible reaction of the output is: ON, OFF, no reaction

**Parameter: “Reaction on exceeding upper threshold”**

**Parameter: “Reaction on falling below lower threshold”**

These parameters are visible if the threshold values are interpreted as hysteresis limits. They define the reaction of the output if the object value “Threshold value” exceeds or falls below the upper or lower threshold. A reaction only occurs if the object value was previously smaller or larger than the lower or upper threshold value. Further explanations can be found in section 3.2.4.

**4.3.10 Detailed description of the objects**

**Object: “Telegr. switch”: 1 Bit (EIS1)**

Switches the output on and off (switching command). If the output is parameterised as a “Normally open contact”, the relay is closed with the telegram value “1” and opened with the telegram value “0” (when parameterised as a “Normally closed contact”, the reverse process is carried out).

**Object: “Status switch”: 1 Bit (EIS1)**

Indicates the current state of the output. It can be inverted via the parameters.

*Standard:* Telegram value “0” Relay is opened  
 “1” Relay is closed

*Inverted:* Telegram value “0”: Relay is closed  
 “1”: Relay is opened

The object is visible if the parameter “Status response of switching state” is set to “yes”. It is sent when there is a change in the value.

**Object: “Telegr. status byte”: 1 Byte (EIS14)**

This object is only visible for the Electronic Switch Actuator Modules ES/M 2.x.1. It provides more detailed information about the operating state of the device. The object value is sent when there is a change in the value.

Bit	Meaning
0 (LSB)	Overload (e.g. short circuit) at output A
1	Overload (e.g. short circuit) at output B
2	Not used, always “0”
3	Not used, always “0”
4	Not used, always “0”
5	Not used, always “0”
6	Supply voltage available
7 (MSB)	Type of supply voltage: 0 = AC; 1 = DC

A detailed table to classify the object value can be found in section 5.1.

**Object: “Permanent ON”: 1 Bit (EIS1)**

If this object receives the value “1”, the output is permanently switched on when the staircase lighting function is used. When permanent ON has finished (telegram value “0”), the reaction can be parameterised.

**Object: “Warning stairc. lighting”: 1 Bit (EIS1)**

This object can be enabled in the “Staircase lighting” time function via the parameters. During the warning time, the object receives the value “1” before the staircase lighting time has elapsed. The user can thus be warned for example by triggering a push button LED.

**Object: “Duration of staircase lighting”: 2 Byte (EIS10)**

The staircase lighting time ( $t_{ON}$ ) can be modified via this object. The time is indicated in seconds. On recovery of the supply voltage, the object value is overwritten by the originally parameterised value.

This object is visible if “yes” is entered under the parameter *Duration of staircase lighting can be changed by object*.

Note: The staircase lighting time cannot be shorter than the warning time. The warning is always carried out by switching on/off briefly.

**Objects: “Call preset 1/2” and “Call preset 3/4”: 1 Bit (EIS1)**

Retrieves a parameterisable switching state. The object values “0” or “1” retrieve the switching states “Preset1” or “Preset2” and “Preset3” or “Preset4”.

It is possible to set a further option for “Preset1” or “Preset3” that the status is restored before retrieving “Preset2” or “Preset4” or that the switching state is reset to the parameterised value. This is advisable if preset2 or preset4 can be stored.

**Objects: “Set preset 1/2” and “Set preset 3/4”: 1 Bit (EIS1)**

Stores the current switching state of the output as the new preset value. Telegram value “0” stores preset1, telegram value “1” stores preset2.

If the special function *“restore old value before preset2”* or *“restore parameterised value of preset2”* is assigned to preset1, the telegram value “0” is ignored.

**Object: “8-bit scene”: 1 Byte (non EIS)**

The device receives a scene number (0...63) via this object together with the information about whether a scene should be retrieved or the current brightness should be stored in the scene.

Bitwise telegram code: MxSSSSSS  
(MSB) (LSB)

- M: 0 – Scene is retrieved  
1 – Scene is stored
- x: Not used
- S: Number of the scene (1...64)



The following object values are produced:

Object value		Meaning
decimal	hexadecimal	
00 or 64	00h or 40h	Retrieve scene 1
01 or 65	01h or 41h	Retrieve scene 2
02 or 66	02h or 42h	Retrieve scene 3
...	...	...
63 or 127	3Fh or 7Fh	Retrieve scene 64
128 or 192	80h or B0h	Set scene 1
129 or 193	81h or B1h	Set scene 2
130 or 194	82h or B2h	Set scene 3
...	...	...
191 or 255	AFh or FFh	Set scene 64

**Objects: “Logical connection 1” and “Logical connection 2”: 1 Bit (EIS1)**

The object “Telegr. switch” can be logically linked with these objects. The logic function can be set in the parameters.

The “Telegr. switch” object is first linked with “Logical connection 1”. The result is then linked with “Logical connection 2”.

**Object: “Priority / forced operation”: 1 Bit or 2 Bit (EIS1 / EIS8)**

An output can be positively driven via this object (e.g. through priority control).

*Forced operation via 1-bit object:*

If this object receives the value “1”, the output is forced into a parameterisable position (e.g. through priority control). The output state cannot be changed until the forced operation has finished (object value “0”).

Telegram value	“0”	Forced operation inactive
	“1”	Forced operation active

*Forced operation via 2-bit object*

At the end of the forced operation, the state that would have existed without forced operation is always restored. The device thus continues to operate normally in the background during the forced operation. The output however is not modified.

The object is visible if the parameter “Enable function ‘forced operation’” is set to “yes, via 2-bit object”.

Telegram value	“0”, “1”	Forced operation cancelled
	“2”	Switch off positively
	“3”	Switch on positively

**Object: “Threshold value”: 1 Byte or 2 Byte (EIS6 / EIS5)**

The output can receive a value via this object. If this value falls below or exceeds a parameterisable threshold value, a switching operation can be carried out.

A 1-byte integer value and a 2-byte floating point value are possible as data types (can be set in the parameters).

4.4 Operating mode: "Heating actuator"

The function "Heating actuator" switches an electronic relay which is generally used to control an electrothermal valve drive. The device is normally controlled by a room thermostat. Various types of control are possible (e.g. continuous-action control).

The electrothermal valve drive can be controlled via 2-step control or pulse width modulation. With pulse width modulation, the control is carried out via a variable interpulse ratio. The following diagram clarifies this:

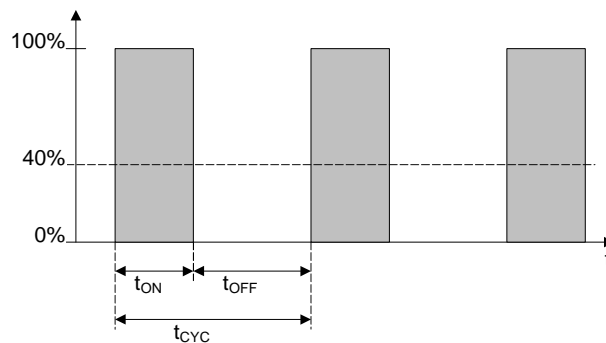
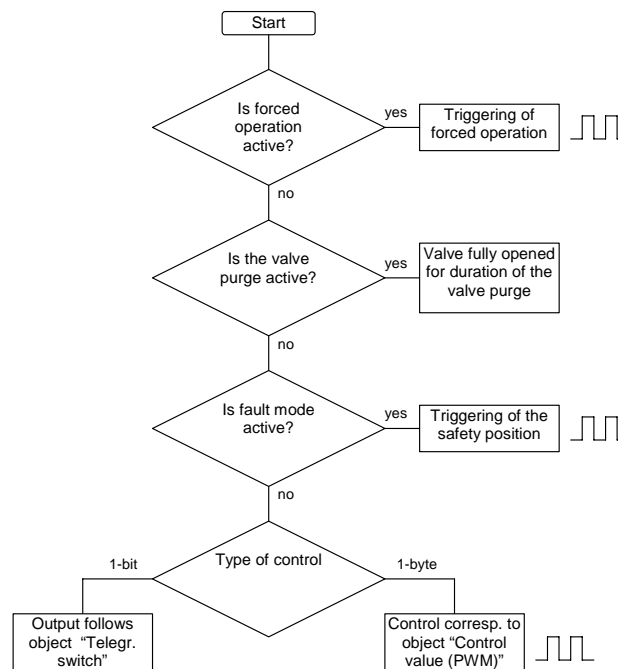

Figure 1: Pulse width modulation

During the period  $t_{ON}$ , the valve is triggered with OPEN, while during the period  $t_{OFF}$ , it is triggered with CLOSE. Due to  $t_{ON} = 0.4 \times t_{CYC}$ , the valve is set at approx. 40%.  $t_{CYC}$  is the so-called PWM cycle time for continuous-action control.

The actuator can trigger a specific valve position during "Forced operation", "Valve purge" and a safety position. The following diagram provides an overview:



## 4.4.1 Overview of the objects

No	Function	Object name	Data type	Flags
0/15	Telegr. switch	Output x	1 Bit (EIS1)	CW
Switches the output directly: "0": Valve closes "1": Valve opens				
0/15	Control value (PWM)	Output x	1 Byte (EIS6)	CW
Determines the control value of the valve via the interpulse ratio (pulse width modulation) of the output.				
1/16	Status switch	Output x	1 Bit (EIS1)	CT
Reports the switching state of the valve control (valve is opened / closed).				
3/18	Forced operation	Output x	1 Bit (EIS1)	CW
Sets the output to a defined state and disables it. This object is visible if 1-bit forced operation is enabled in the parameters. On receipt of the value "1", the forced operation function is activated and the output triggers the set valve position. The forced operation is finished on receipt of the value "0".				
4/19	Trigger valve purge	Output x	1 Bit (EIS1)	CW
This object is visible if the purge function is enabled in the parameters. On receipt of the value "1", the valve is opened for the duration of the valve purge. The valve purge is ended on receipt of the value "0".				
5/20	Telegr. status valve purge	Output x	1 Bit (EIS1)	CT
Indicates that the valve purge is active.				
11/26	Telegr. fault thermostat	Output x	1 Bit (EIS1)	CT
Indicates a possible fault with the room thermostat.				
29	Telegr. status byte	Output A...B	1 Byte (EIS14)	CRT
This object provides further information about the operating state of the device (only Electronic Switch Actuator Modules ES/M 2.x.1).				

**4.4.2 Parameter window: “A: General”**

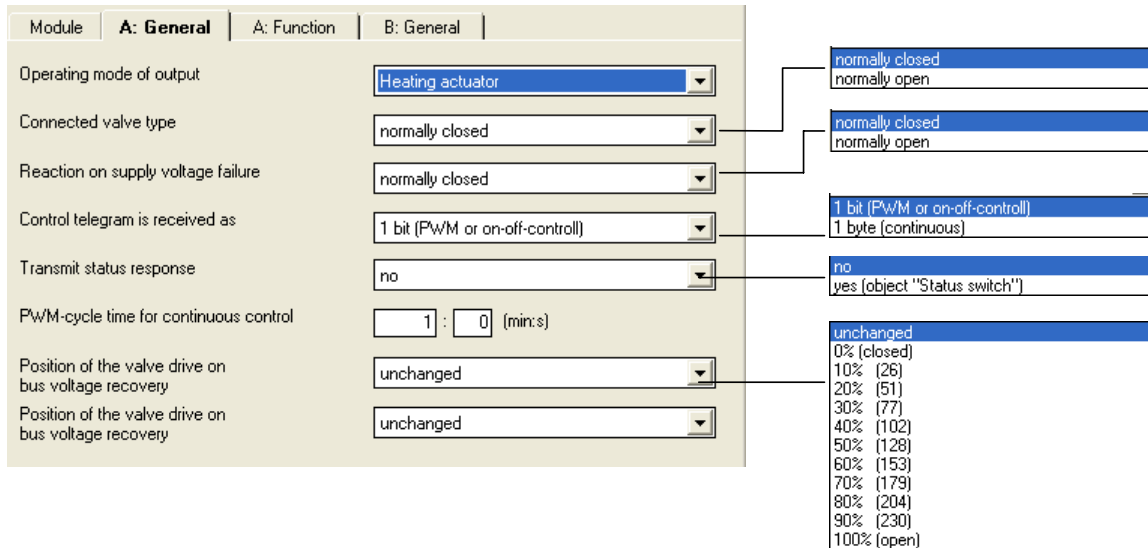

**Parameter: “Connected valve type”**

It can be set in this parameter whether a valve should be controlled as “normally closed” or “normally open”. If the valve is normally closed, the OPENING of the valve is achieved via the closing of the relay. If the valve is normally open, the OPENING of the valve is achieved by the opening of the relay.

**Parameter: “Control telegram is received as”**

The heating actuator can either be controlled via the 1-bit object “Telegr. switch” or the 1-byte object “Control value (PWM)”.

In 1-bit control, the heating actuator functions in a similar way to a standard switch actuator: The room thermostat controls the heating actuator via standard switching commands. A 2-step control or pulse width modulation of the control value can be implemented in this way.

For 1-byte control, a value of 0..255 (corresponds to 0%..100%) is preset by the room thermostat. This process is also known as “continuous-action control”. The valve is closed at 0% and fully opened at 100%. The heating actuator controls intermediate values via pulse width modulation (see diagram above).

**Parameter: “Transmit status response”**

This parameter switches the object “Status switch” and defines its function. The object can have various functions depending on whether the actuator is controlled via a 1-bit or 1-byte object. The following table provides an overview:

<b>1-bit (PWM or 2-step)</b>	Object value is identical to the value of the object “Telegr. switch”.
<b>1-byte (continuous)</b>	The object value corresponds to the current control of the valve. The valve is opened for “ON” and closed for “OFF”.

**Parameter: “PWM cycle time for continuous control”**

The interpulse period of the pulse width modulation for continuous-action control is set here (corresponds to  $t_{CYC}$  in Figure 1).

For 2-step control (1-bit control), the pulse width modulation is only used in fault mode, during forced operation and directly after bus voltage recovery.

**Parameter: “Reaction on supply voltage failure”**

On failure of the supply voltage, the Room Controller has no function. The output can be set to a defined state with this parameter.

This parameter is only visible for the Switch Actuator Module SA/M 2.6.1. The Electronic Switch Actuator Modules ES/M 2.xx.1 always switch off on failure of the supply voltage (high-resistance).

**Parameter: “Position of the valve drive on bus voltage failure”**

This parameter sets how the valve drive is triggered on failure of the bus voltage. The parameterised value is set as the PWM cycle time.

**Parameter: “Position of the valve drive on bus voltage recovery”**

This parameter sets how the valve drive is triggered after bus voltage recovery until the first switching or positioning command is received from the room thermostat. The parameterised value is set as the PWM cycle time.

**4.4.3 Parameter window: “A: Function”**

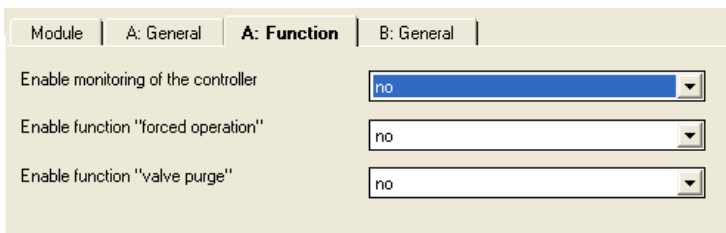

**Parameter: “Enable monitoring of the controller”**

The cyclic monitoring of the room thermostat can be enabled here. The failure of the thermostat can thus be detected. The output switches to fault mode and moves to a defined position.

**Parameter: “Enable function ‘forced operation’”**

The forced operation of the output can be enabled here in order to move the outputs to a specific position e.g. for inspection purposes.

**Parameter: “Enable function ‘valve purge’”**

The cyclic valve purge can be enabled here to prevent deposits from forming in the valves.

**4.4.4 Parameter window: “A: Monitoring”**

This parameter window is visible if the value “yes” has been entered in the parameter *Enable monitoring of the controller* in the parameter window “x: Function”.

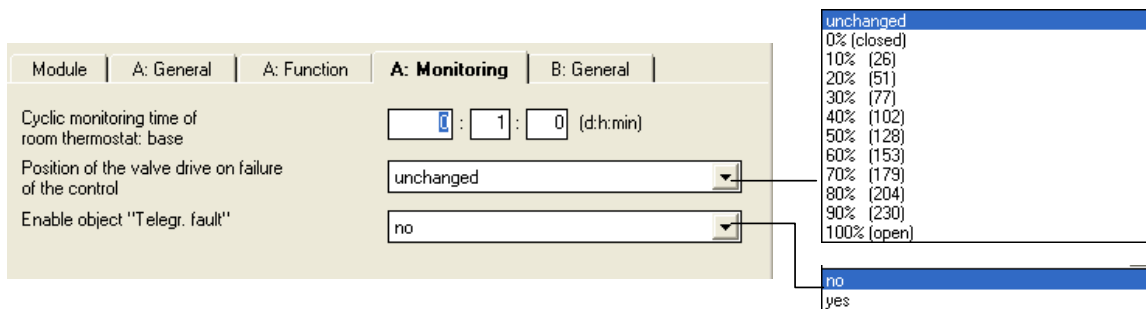

**Parameter: “Cyclic monitoring time of room thermostat”**

The telegrams of the room thermostat are transferred to the electronic actuator at specific intervals. If one or more of the subsequent telegrams is omitted, this can indicate a communications fault or a defect in the room thermostat. If there are no telegrams to the objects “Telegr. switch” or “Control value (PWM)” during the period defined in this parameter, the actuator switches to fault mode and triggers a safety position. The fault mode is ended as soon as a telegram is received.

**Note:** If this parameter window is visible, the room thermostat must send the control value cyclically, otherwise no function is possible. The monitoring time should be greater than the cyclic transmission time (recommended: Factor 2).

**Parameter: “Position of the valve drive on failure of the control”**

The safety position which is triggered by the actuator in fault mode is defined here. The switch cycle time  $t_{CYC}$  of the control is defined in the parameter “PWM cycle time for continuous control”.

**Parameter: “Enable object ‘Telegr. fault’”**

The object “Telegr. fault thermostat” which can display the failure of the room thermostat can be enabled in this parameter.

**4.4.5 Parameter window: “A: Forced operation”**

The function can be activated and deactivated via the object “Forced operation”. During a forced operation, the actuator triggers a freely adjustable forced position which can no longer be changed. This has the highest priority i.e. it is not modified by a valve purge or safety position.

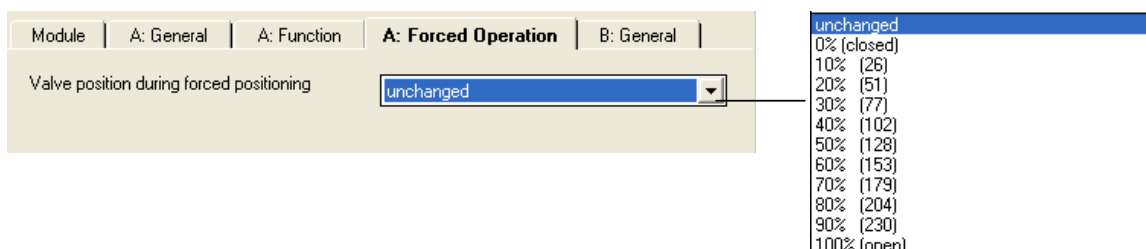

**Parameter: “Valve position during forced positioning”**

The valve position triggered by the actuator during the forced operation is defined in this parameter. The switch cycle time  $t_{CYC}$  of the control is defined in the parameter “*PWM cycle time for continuous control*”.

**4.4.6 Parameter window: “A: Valve purge”**

Regular purging of a heating valve can prevent deposits from forming in the valve area and restricting the valve function. This is particularly important at times when the valve position does not change very much. The valve is opened to the maximum during a valve purge. It can be triggered via the object “Trigger valve purge” and/or automatically at adjustable intervals.

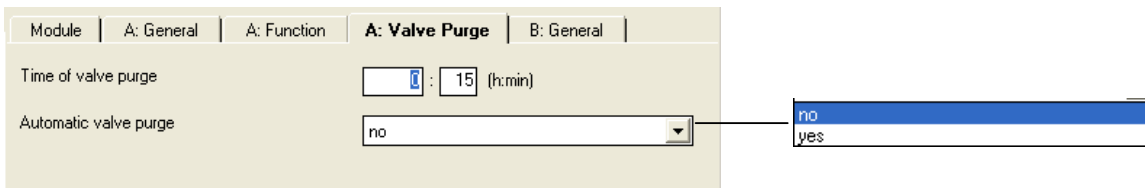

**Parameter: “Time of valve purge”**

The duration of a valve purge is set here.

**Parameter: “Automatic valve purge”**

If “yes” is entered in this parameter, the valve is automatically purged at adjustable intervals.

**Parameter: “Period between valve purges”**

This parameter is visible for automatic valve purging. It defines the interval between two valve purges.

**4.4.7 Detailed description of the objects**

**Object: “Telegr. switch”: 1 Bit (EIS1)**

This object is visible if the control of the heating actuator is carried out via a 1-bit object. The output is controlled directly, regardless of whether the valve is normally open or normally closed.

Telegram value	“0”	Valve closes
	“1”	Valve opens

**Object: "Control value (PWM)": 1 Byte (EIS6)**

This object is visible if the control of the heating actuator is carried out via an 8-bit object e.g. within continuous-action control. The object value [0..255] determines the control ratio ("interpulse period") of the valve. The valve is closed at object value 0 and fully opened at object value 255.

Telegram value	"0"	Valve closed
	...	
	"255"	Valve fully opened

**Object: "Status switch": 1 Bit (EIS1)**

This object is visible if the status response has been activated in the parameter settings. It reports the switching state of the output. The object value is sent in the event of a change.

When the heating actuator is controlled via a 1-byte object, the behaviour of the object can be set in the parameter "*Transmit status response*":

*"current state of the output"*

Telegram value	"0"	Valve is closed
	"1"	Valve is opened

*"0% = OFF, otherwise = ON"*

Telegram value	"0"	Valve is closed (0%)
	"1"	Valve is not closed (1% ... 100%)

**Object: "Forced operation": 1 Bit (EIS1)**

This object sets the output to a defined state and blocks it. On receipt of the value "1", the forced operation is activated and the output triggers the parameterised valve position. On receipt of the value "0", the forced operation is finished. The object is enabled in the parameters.

**Object: "Trigger valve purge": 1 Bit (EIS1)**

On receipt of the value "ON", the valve is opened for the duration of the valve purge. On receipt of the value "OFF", the valve purge is ended. This object is visible if the purge function has been enabled in the parameters.

**Object: "Telegr. status valve purge": 1 Bit (EIS1)**

This object indicates that the valve purge is active.

Telegram value	"0"	Valve purge is not active
	"1"	Valve purge is active

**Object: "Telegr. fault thermostat": 1 Bit (EIS1)**

This object indicates a possible fault of the room thermostat. The object "Telegr. switch" or "Control value (PWM)" can be monitored cyclically. If the object value is not available for an adjustable period, the device assumes that the room thermostat has failed and reports a fault.

Telegram value	"0"	No fault
	"1"	Fault



**Object: "Telegr. status byte": 1 Byte (EIS14)**

This object is only visible for the Electronic Switch Actuator Modules ES/M 2.x.1. It provides more detailed information about the operating state of the device. The object value is sent when there is a change in the value.

Bit	Meaning
0 (LSB)	Overload (e.g. short circuit) at output A
1	Overload (e.g. short circuit) at output B
2	Not used, always "0"
3	Not used, always "0"
4	Not used, always "0"
5	Not used, always "0"
6	Supply voltage available
7 (MSB)	Type of supply voltage: 0 = AC; 1 = DC

A detailed table to classify the object value can be found in section 5.1.

#### 4.5 Operating mode: “Fan coil control”

The application provides the opportunity of controlling a fan coil air-conditioning device.

If this operating mode is selected, this output has the master function in fan coil control. On the one hand, it controls fans speed 1 directly while on the other hand it controls further outputs of switch actuator modules via communication objects which switch valves and other fan speeds. These outputs are parameterised in the “Slave” function.

##### 4.5.1 What is a fan coil unit?

A fan coil unit consists of one or two cooling or heating circuits which are controlled via valves. The valves are controlled via the outputs of the switch actuator (on/off). There is also a fan which blows on the heat exchanger. It can be controlled in stages (generally 3 speeds):

Control value (example)	Fan speed	Output 1	Output 2	Output 3
0...30%	Speed 1	ON	OFF	OFF
30...60%	Speed 2	OFF	ON	OFF
e.g. 60...100%	Speed 3	OFF	OFF	ON

##### 2-pipe system

With a 2-pipe system, only hot or cold water flows through the fan coil unit. The device therefore only has one heat exchanger.

##### 4-pipe system

In a 4-pipe system, the fan coil unit has separate connections for hot and cold water. The device thus has two heat exchangers.

##### 4.5.2 Overview of the objects

###### Objects for the “Master” function

No	Function	Object name	Data type	Flags
0/15	Control value heating	Output x, Master	1 Byte (EIS6)	CW
The heat output is preset by the room thermostat via this object.				
1/16	Control value cooling	Output x, Master	1 Byte (EIS6)	CW
The cooling capacity is preset by the room thermostat via this object.				
2/17	Speed limitation	Output x, Master	1 Bit (EIS1)	CW
Used to limit the fan speed to a maximum value.				
3/18	Forced operation	Output x, Master	1 Bit (EIS1)	CW
Sets a fixed fan speed and valve position for the fan coil controller and disables them				
4/19	Toggle heating/cooling	Output x, Master	1 Bit (EIS1)	CW
In the operating mode “2-pipe system, heating and cooling”, it gives the fan coil controller the information about whether hot or cold water is being supplied.				
5/20 6/21 7/22 8/23	Slave fan speed 2 Slave fan speed 3 Slave fan speed 3 Slave fan speed 5	Output x, Master	1 Bit (EIS1)	CRT
The master output controls further outputs via these objects which are used to control the ventilation.				

No	Function	Object name	Data type	Flags
<b>9/24</b>	<b>Slave valve</b>	<b>Output x, Master</b>	<b>1 Bit (EIS1)</b>	<b>CRT</b>
Visible when controlling a 2-pipe system. Via these objects, the master controls a slave output which in turn controls the valve.				
<b>9/24</b>	<b>Slave valve heating</b>	<b>Output x, Master</b>	<b>1 Bit (EIS1)</b>	<b>CRT</b>
Visible when controlling a 4-pipe system. Via these objects, the master controls a slave output which in turn controls the valve for the heating circuit.				
<b>10/25</b>	<b>Slave valve cooling</b>	<b>Output x, Master</b>	<b>1 Bit (EIS1)</b>	<b>CRT</b>
Visible when controlling a 4-pipe system. Via these objects, the master controls a slave output which in turn controls the valve for the cooling circuit.				
<b>11/26</b>	<b>Telegr. fault</b>	<b>Output x, Master</b>	<b>1 Bit (EIS1)</b>	<b>CT</b>
Indicates a possible fault of the room thermostat. The fan coil controller is in the safety position.				
<b>12/27</b>	<b>Status switch</b>	<b>Output x</b>	<b>1 Bit (EIS 1)</b>	<b>CT</b>
This object reports the current state of the output.				
<b>29</b>	<b>Telegr. status byte</b>	<b>Output A...B</b>	<b>1 Byte (EIS14)</b>	<b>CRT</b>
This object provides further information about the operating state of the device (only Electronic Switch Actuator Modules ES/M 2.x.1).				

**Object for the "Slave" function**

No	Function	Object name	Data type	Flags
<b>0/15</b>	<b>Fan coil slave</b>	<b>Output x</b>	<b>1 Bit</b>	<b>CW</b>
This object is used to control the output via the master.				

### 4.5.3 Parameter window: “A: General”

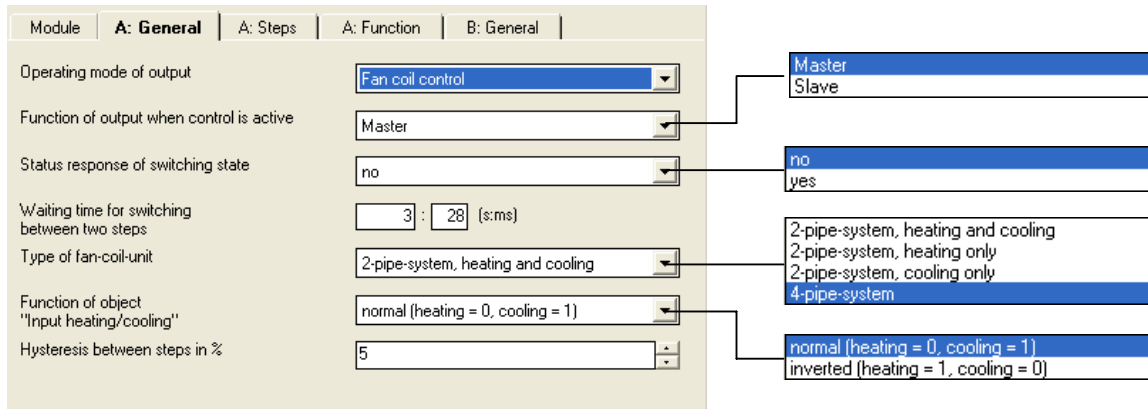

#### Parameter: “Function of output when control is active”

It can be set here whether the device operates as a “Master” or “Slave” in fan coil control mode.

There can only be one output with the master function per fan coil unit. This output controls fan speed 1. The master controls valve drives or further fan speeds via communication objects. These outputs must then be parameterised with the “Slave” function.

**Note:** Outputs with the slave function should be parameterised as such. If parameterised e.g. as a “Switch actuator”, there is the danger that more than one output is closed under unfavourable conditions. The fan motor for example can be damaged as a result.

Outputs with the slave function are only controlled via the object “Fan coil slave”. The following parameters are only visible in the “Master” setting.

#### Parameter: “Status response of switching state”

The object “Status switch” can be enabled via this parameter if the status of the output is reported on the bus.

#### Parameter: “Waiting time for switching between two speeds”

The operating time is delayed to enable an idle period when switching over the motor or valve or to prevent the period that they are switched on/off from being too short. The value range can be set between 500 ms and 1 min.

#### Parameter: “Type of fan coil unit”

It is possible to choose between the following types of fan coil unit:

- “2-pipe system, heating and cooling”
- “2-pipe system, heating only”
- “2-pipe system, cooling only”
- “4-pipe system”

In a two-pipe system, only hot or cold water flows through the fan coil unit and the device therefore only has one heat exchanger. In a 4-pipe system, the fan coil unit has separate connections for hot and cold water. The device therefore has two heat exchangers.

#### Parameter: “Function of object ‘Toggle heating/cooling’”

The object “Toggle heating/cooling” can be inverted via this parameter. This is preset by the room thermostat.

**Parameter: “Hysteresis between fan speeds in %”**

If a fan value fluctuates around a fan speed, the ventilation would be operated continually. This can be prevented by setting a hysteresis.

**4.5.4 Parameter window: “A: Speeds”**

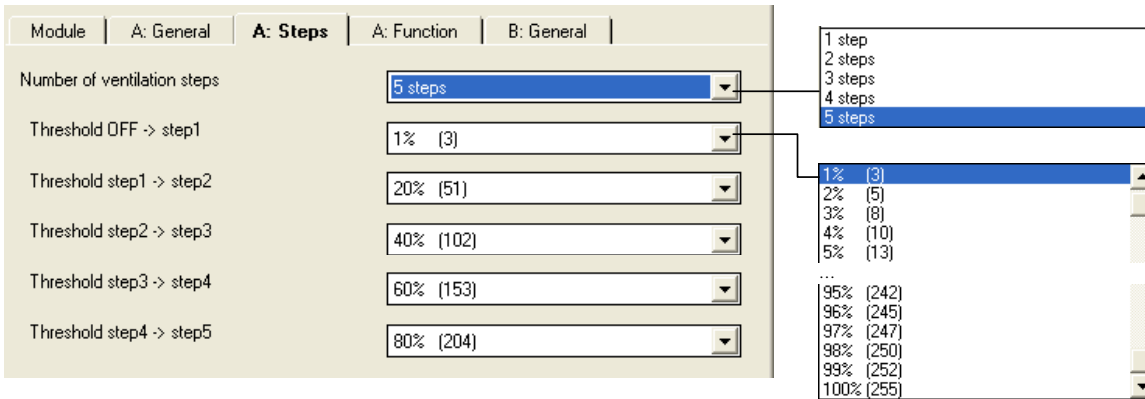

**Parameter: “Number of fan speeds”**

It can be set here how many fan speeds the fan coil unit has. It is possible to set between “1 speed” and “5 speeds”. The corresponding objects “Slave fan speed 2” to “Slave fan speed 5” are enabled.

**Parameter: “Threshold OFF → speed1” to “... speed4 → speed5”**

These parameters are visible depending on the number of fan speeds. The threshold values of the control value from which a fan switches up or down must be entered here.

**4.5.5 Parameter window: “A: Function”**

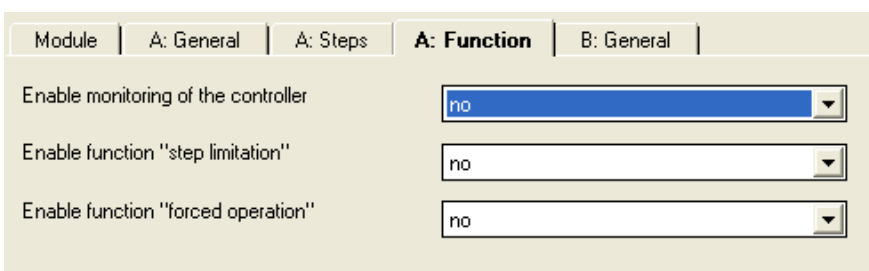

**Parameter: “Enable monitoring of the controller”**

The cyclical monitoring of the room thermostat can be enabled here. The failure of the room thermostat can thus be detected. The output then switches to fault mode and moves to a defined position.

**Parameter: “Enable function ‘speed limitation’”**

This function enables e.g. noise reduction via the bus during operation at night.

**Parameter: “Enable function ‘forced operation’”**

The forced operation of the fan speed and the valve position can be enabled here in order to move outputs into a specific position e.g. for inspection purposes.

**4.5.6 Parameter window: “A: Monitoring”**

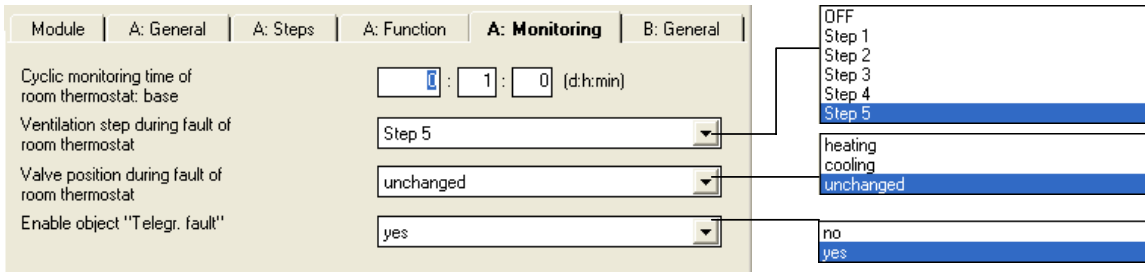

The cyclic monitoring of the room thermostat via the objects “Control value heating” and “Control value cooling” can be enabled here. As soon as the objects are not received for a certain period, the device switches to fault mode (object “Telegr. fault” = “1”).

Cyclic monitoring may only be enabled if the room thermostat sends the objects “Heating” and/or “Cooling” cyclically.

**Parameter: “Cyclic monitoring time of room thermostat”**

This parameter is visible if cyclic monitoring has been enabled. The cyclic monitoring time is set here.

**Parameter: “Fan speed during fault of room thermostat”**

This parameter is visible if cyclic monitoring has been enabled. It defines which fan speed and valve position are triggered during fault mode.

**Parameter: “Valve position during fault of room thermostat”**

It can be set here whether heating or cooling should be carried out in fault mode or whether the current setting should be maintained.

**Parameter: “Enable object ‘Telegr. fault’”**

The object “Telegr. fault” which can indicate the failure of the room thermostat can be enabled in this parameter.

**4.5.7 Parameter window: “A: Speed limitation”**

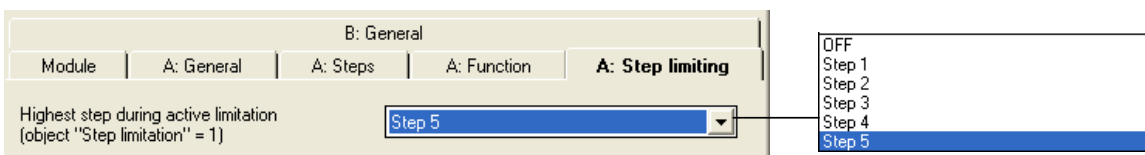

**Parameter: “Highest speed during active limitation”**

The highest fan speed during active step limitation is set here (see object “Speed limitation”).

**4.5.8 Parameter window: “A: Forced operation”**

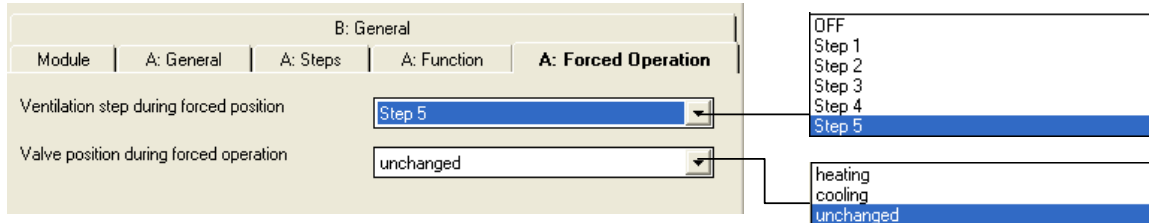

During a forced operation, the actuator triggers a freely adjustable forced position. This has the highest priority i.e. it is not modified by a valve purge or safety position. The forced operation can be activated via the object “Forced operation” = ON and deactivated via “Forced operation” = OFF.

**Parameter: “Fan speed during forced position”**

This parameter defines which fan speed and valve position are triggered during the forced operation.

**Parameter: “Valve position during forced operation”**

The valve position triggered by the actuator during forced operation is defined in this parameter. The switch cycle time  $t_{CYC}$  of the control is defined in the parameter “PWM cycle time for continuous control”.

**4.5.9 Detailed description of the objects**

**Object: “Control value heating”: 1 Byte (EIS6)**

The heat output is specified via this object. The object value is sent e.g. by a room thermostat.

Telegram value    “0”    No heat output  
 ...  
                          “255” Maximum heat output

**Object: “Control value cooling”: 1 Byte (EIS6)**

The cooling capacity is specified via this object. The object value is sent e.g. by a room thermostat.

Telegram value    “0”    No cooling capacity  
 ...  
                          “255” Maximum cooling capacity

**Object: “Speed limitation”: 1 Bit (EIS1)**

The fan speed can be limited to a maximum value via this object. This prevents the fan from exceeding a specific speed e.g. at night (noise reduction).

Telegram value    “0”    Speed limitation not active  
                          “1”    Speed limitation active

**Object: “Forced operation”: 1 Bit (EIS1)**

A fan speed and valve position can be assigned to the fan coil controller via this object and the controller is disabled. The fan speed and valve position can be parameterised.

Telegram value    “0”    Forced operation not active  
                          “1”    Forced operation active

**Object: “Toggle heating/cooling”: 1 Bit (EIS1)**

This object is visible in the operating mode “2-pipe system, heating and cooling” i.e. the fan coil unit only has one connection for supplying hot or cold water. Via the object, the device receives information from the building control system about whether hot or cold water is supplied. The object “Control value heating” or “Control value cooling” is evaluated accordingly. The object can be inverted.

*Standard:* Telegram value “0” Heat  
 “1” Cool

*Inverted:* Telegram value “0” Cool  
 “1” Heat

**Objects: “Slave fan speed 2” to “ ... 5”: 1 Bit (EIS1)**

Via these objects, the master output controls further outputs which are used for ventilation control. These outputs must be parameterised as slaves.

Telegram value “0” Fan speed switched off  
 “1” Fan speed switched on

**Object: “Slave valve”: 1 Bit (EIS1)**

This object is visible when using a 2-pipe system i.e. there is only one valve. The object controls a further output which in turn controls the valve. The output must be parameterised as a “Slave”. As soon as the fan is running at speed 1 at least, the object value = “1”, otherwise it is “0”.

Telegram value “0” Valve closed  
 “1” Valve opened

**Object: “Slave valve heating” and “ ... cooling”: 1 Bit (EIS1)**

These objects are visible when using a 4-pipe system i.e. there are two valves for heating and cooling. The objects control two further outputs which in turn control two valves. The outputs must be parameterised as a “Slave”.

Telegram value “0” Valve closed  
 “1” Valve opened

**Object: “Telegr. fault”: 1 Bit (EIS1)**

This object indicates a possible fault of the room thermostat. If the object value “Control value heating” or “Control value cooling” is not available for a parameterisable period, it is assumed that the room thermostat has a fault and the fan coil controller reports a fault and switches to the safety position.

Telegram value “0” No fault  
 “1” Fault

**Object: “Status switch”: 1 Bit (EIS1)**

Indicates the current state of the output.

Telegram value “0” Relay opened  
 “1” Relay closed



**Object: "Telegr. status byte": 1 Byte (EIS14)**

This object is only visible for the Electronic Switch Actuator Modules ES/M 2.x.1. It provides more detailed information about the operating state of the device. The object value is sent when there is a change in the value.

Bit	Meaning
0 (LSB)	Overload (e.g. short circuit) at output A
1	Overload (e.g. short circuit) at output B
2	Not used, always "0"
3	Not used, always "0"
4	Not used, always "0"
5	Not used, always "0"
6	Supply voltage available
7 (MSB)	Type of supply voltage: 0 = AC; 1 = DC

A detailed table to classify the object value can be found in section 5.1.

---

ABB i-bus® EIB / KNX

**Switch Actuator Module SA/M 2.6.1**

**2CDG 110 002 R0011**

**Electr. Switch Actuator Module ES/M 2.230.1**

**2CDG 110 013 R0011**

**Electr. Switch Actuator Module ES/M 2.24.1**

**2CDG 110 014 R0011**

---

## 5 Appendix

### 5.1 Ordering information

Description	Type	Order no.	bbn 40 16779 EAN	Unit price [EURO]	Price group	Unit weight [kg]	Pack unit [pc.]
Switch Actuator Module, 2-fold, 6 A	SA/M 2.6.1	2CDG 110 002 R0011	583145		26		1
Electr. Switch Actuator Module, 2-fold, 230 V AC	ES/M 2.230.1	2CDG 110 013 R0011	583619		26		1
Electr. Switch Actuator Module, 2-fold, 24 V DC	ES/M 2.24.1	2CDG 110 014 R0011	583626		26		1