

Product name: **2-channel push button interface**

Design: UP (flush-mounting type)

Item no.: **1118 00**

ETS search path: Gira Giersiepen / input / binary input, 2fold / Universal push button interface 2fold

Functional description:

The 2-channel push button interface has 2 independent channels which – depending on parameterization – can be used as inputs or alternatively as outputs. The push button interface can therefore be used to poll its inputs for the switching state of up to 2 potential-free push buttons/switches with a common reference potential and send the corresponding telegrams to the instabus. These may be telegrams for switching or dimming, shutter/blind control or value transmitter applications (dimming value transmitter, light-scene extension, temperature or brightness value transmitter). Moreover, 2 switching event counters or 1 pulse counter (only channel 1) are available.

Channels 1 and 2 can be used alternatively as independent outputs for controlling up to two LEDs. To increase the output current (cf. Technical Data), the channels can also be connected in parallel if they are parameterized alike. The outputs are short-circuit-proof and protected against overloading and false polarity.

Connecting 230 V signals or other external voltages to the inputs is not permitted.

Layout:

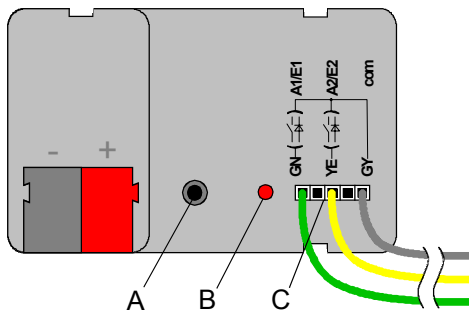

Dimensions:

Width (W): 44 mm

Height (H): 16 mm

Depth (D): 29 mm

Controls:

A Programming button

B Programming LED (red)

C Connecting wires
green: channel 1
yellow: channel 2
grey: reference potential (com)

Technische Daten:

Instabus EIB supply

Voltage: 21 - 32 V DC SELV

Power consumption: typ. 150 mW

Connection: bus connecting and branching terminal

External supply ---

Inputs:

Number: up to 2 (depending on parameterization: channel 1 to 2)

Line length: 25 cm prefabricated, extendable to 5 m max.

Scanning voltage: continuous signal

Loop resistance: max. 2 kOhm for safe detection of a "1" signal (rising edge)

Outputs:

Number: up to 2 (depending on parameterization: channel 1 and/or 2)

Line length: 25 cm prefabricated, extendable to 5 m max

Output current: max. 0.8 mA per output channel (at 1.5 V; typ. for red low-current LED)
For parallel connection, the maximum total output current increases to 1.6 mA. In the event of parallel connection, outputs 1 and 2 must be parameterized exactly alike (none of the output signals flashing)
The outputs are short-circuit-proof, protected against overloading and false polarity.

Output voltage: typ. 1.5 V (e.g. red low-current LED)
(5 V with outputs open circuit)

instabus EIB System

Sensor

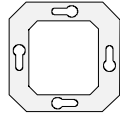

Response to voltage failure	
Bus voltage only:	no response (outputs switching off)
Mains voltage only:	---
Bus and mains voltages:	---
Response to return of voltage	
Bus voltage only:	the response of the inputs and the outputs can be parameterized (cf. "Response to return of bus voltage").
Mains voltage only:	---
Bus and mains voltages:	---

Type of protection:	IP 20
Safety class:	III
Mark of approval:	KNX / EIB
Ambient temperature:	-5 °C ... +45 °C
Storage / transport temperature:	-25 °C ... +70 °C (storage above +45 °C results in shorter lifetime)
Mounting position:	any
Minimum spacings:	none
Type of fastening:	e.g. placing into deep flush-mounting box (∅ 60 mm x 60 mm)

Connecting diagram:

Terminals:

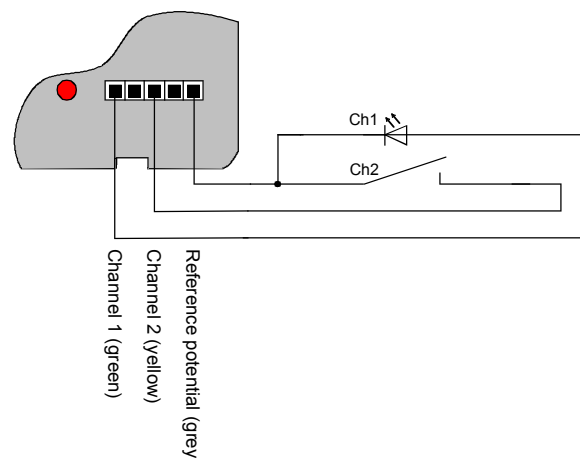
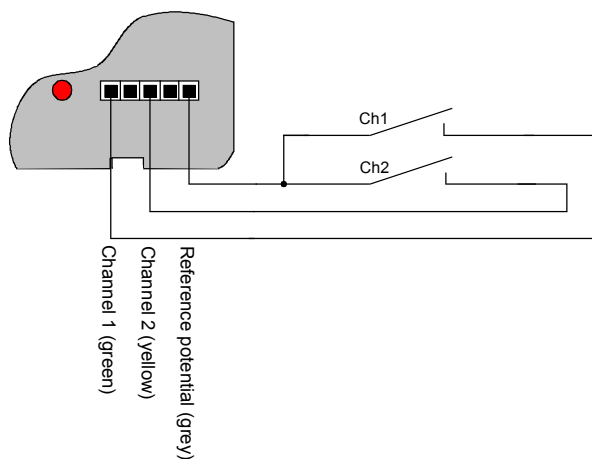

Push button interface used as 2 inputs

Example of push button interface used with 1 inputs and 1 outputs

Important: - Connect only potential-free switches or push buttons to the inputs.
- To obtain sufficient signalling brightness, it is recommended to connect "low-current LEDs" to the outputs.

Hardware information:

- To avoid EMC-related interference, the lines to the inputs should not be laid parallel to lines carrying mains voltage.
- Connecting 230 V signals or other external voltages to the inputs is not permitted.
- The voltage potentials on the lines connecting the contacts or the LEDs are not electrically isolated from the bus voltage.

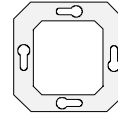

Software description:

ETS search path:

Gira Giersiepen / input / binary input, 2fold / Universal push putton interface 2fold

ETS-symbol:

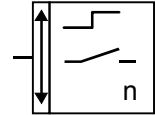

Applications:

Brief description:

Name:

Date:

Page:

Data base

2 inputs or alternatively

2 inputs, 2 outputs 705801

10.04

4

11189190

1 input, 1 output resp.

2 outputs

instabus EIB System

Sensor

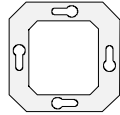

Application: 2 inputs, 2 outputs 705801

Scope of functions

Binary inputs:

General

- "Switching", "dimming", "shutter/blind", "value transmitter" and "switching event counter" functions freely assignable to the max. 2 inputs
- "Pulse counter" function freely assignable to input 1
In the "pulse counter" function parameterized for input 1, input 2 will be reserved for the sync signal. For this reason, input 2 must be parameterized as "Pulse counter / Sync input".
- Disabling object for disabling of individual inputs (polarity of disabling object presettable)
- Delay on return of bus voltage and debouncing time centrally adjustable
- Response to bus voltage return separately parameterizable for each input
- Telegram rate limitation generally parameterizable for all inputs

Switching function

- Two independent switching objects available for each input (switching commands individually parameterizable)
- Command for rising and falling edge individually adjustable (ON, OFF, TOGGLE, no reaction).
- Independent cyclical transmission of switching objects depending on edge or on object value selectable.

Dimming function

- Single-sided and double-sided actuation
- Time between dimming and switching and dimming step width presettable
- Telegram repetition and stop telegram transmission possible

Shutter/blind function

- Command for rising edge adjustable (no function, UP, DOWN, TOGGLE)
- Operating concept parameterizable ("step - move - step" resp. "move - step")
- Time between STEP and MOVE operation presettable (only with "step - move - step")
- Slat adjustment time presettable (time during which a "Move" command can be terminated by releasing a push button on the input)

Value transmitter and light-scene extension functions

- Edge (push button as n.o. contact, push button as n.c. contact, switch) and value for edge parameterizable
- Value change in push button mode possible with long press on the button for value transmitter
- In light-scene extension with storage function, a light-scene can be stored without preceding recall

Temperature and brightness value transmitter functions

- Edge (push button as n.o. contact, push button as n.c. contact, switch) and value for edge parameterizable
- Value change in push button mode possible with long press on the button

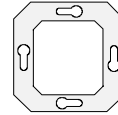
**Pulse counter function**

- Edge for pulse count and time interval for counter status transmission parameterizable
- Edge of sync signal for resetting of counter status and switching telegram on arrival of sync signal depending on edge presettable

Switching event counter function

- Edge for counting of signal at input and maximum reading of counter selectable
- Step width for counter status output and command (no telegram, ON, OFF, TOGGLE) on reaching the maximum reading of counter parametrizable

Outputs:

- Independent switching of max. 2 outputs
- Outputs parameterizable as n.o. contact (ON: output supplies current / OFF: output supplies no current) or as n.c. contact (ON: output supplies no current / OFF: output supplies current)
- Preferred state on return of bus voltage presettable
- For each output additional feedback and additional function possible:
- Presettable additional functions: - logic-operation function with 3 logic parameters
- disabling function with presettable disabling behaviour of the relays
- priority-position function to fix the priority of arriving switching telegrams
- Feedback object invertible
- Delay on return of bus voltage centrally presettable
- Turn-on delay and/or turn-off delay or timer function separately presettable for each output
- Output signal as flashing signal (flashing frequency parameterizable in 3 steps)

instabus EIB System

Sensor

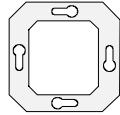

Object

Object description

Objects for binary inputs:

☐ 0 – 1	Switching object X.1:	1-bit object for transmitting switching telegrams (ON, OFF) (1 st switching object)
☐ 8 – 9	Switching object X.2:	1-bit object for transmitting switching telegrams (ON, OFF) (2 nd switching object)
☐ 8 – 9	Switching:	1-bit object for transmitting switching telegrams (ON, OFF) for the dimming function
☐ 8 – 9	Dimming:	4-bit object for relative brightness variation between 0 and 100 %
☐ 0 – 1	Short-time operation:	1-bit object for STEP operation of a shutter
☐ 8 – 9	Long-time operation:	1-bit object for MOVE operation of a shutter
☐ 0 – 1	Value:	1-byte object for transmitting value telegrams (0 - 255)
☐ 0 – 1	Light-scene extension:	1-byte object for recalling and storing light-scenes (1 - 64)
☐ 8 – 9	Temperature value:	2-byte object for adjusting a fixed temperature value (0 - 40 °C)
☐ 8 – 9	Brightness value:	2-byte object for adjusting a fixed brightness value (0 - 1500 lux)
☐ 1	Sync signal pulse counter X:	1-bit object for transmitting switching telegrams depending on the sync signal
☐ 8	Pulse counter X status:	2-byte object for transmitting the pulse counter status
☐ 0 / 1	Switching event counter:	1-bit object for transmitting switching telegrams depending on counter status
☐ 8 / 9	Switching event counter:	2-byte object for transmitting the counter status
☐ 16 – 17	Disabling:	1-bit object for disabling individual binary inputs (polarity parameterizable)

Objects for (LED) outputs:

☐ 0 – 1	Switching:	1-bit object for controlling an (LED) output
☐ 8 – 9	Logic operation:	1-bit object for logic-operation control of an (LED) output (ON: Logic-operation input "1" / OFF: Logic-operation input "0")
☐ 8 – 9	Disabling:	1-bit object for disabling an (LED) output (polarity parameterizable)
☐ 8 – 9	Priority position:	2-bit object for priority priority-position control of an (LED) output
☐ 16 – 17	Feedback:	1-bit object for switching status feedback of an (LED) output (feedback invertible)

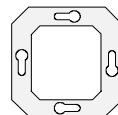

Number of addresses (max.):	26	dynamic table management:	Yes <input checked="" type="checkbox"/> No <input type="checkbox"/>
Number of assignments (max.):	27	maximum table length:	53
Communication objects:	6		

Function: no function (for all 2 inputs ²)

No further input objects!

Function: Binary input / "Switching" (for all 2 inputs ²)

Object:	Function:	Name:	Type:	Flag:
<input checked="" type="checkbox"/> 0 – 1	Switching object X.1	Input 1 – Input 2	1 bit	C,W,T,(R) ¹
<input checked="" type="checkbox"/> 8 – 9	Switching object X.2	Input 1 – Input 2	1 bit	C,W,T,(R) ¹

Function: Binary input / "Dimming" (for all 2 inputs ²)

Object:	Function:	Name:	Type:	Flag:
<input checked="" type="checkbox"/> 0 – 1	Switching	Input 1 – Input 2	1 bit	C,W,T,(R) ¹
<input type="checkbox"/> 8 – 9	Dimming	Input 1 – Input 2	4 bit	C,T,(R) ¹

Function: Binary input / "Shutter/blind" (for all 2 inputs ²)

Object:	Function:	Name:	Type:	Flag:
<input type="checkbox"/> 0 – 1	Step operation	Input 1 – Input 2	1 bit	C, W, (R) ¹
<input type="checkbox"/> 8 – 9	Move operation	Input 1 – Input 2	1 bit	C, T, (R) ¹

Function: Binary input / "Value transmitter" (Function: dimming value transmitter for all 2 inputs ²)

Object:	Function:	Name:	Type:	Flag:
<input type="checkbox"/> 0 – 1	Value	Input 1 – Input 1	1 byte	C, W, (R) ¹

Function: Binary input / "Value transmitter" (Function: Light-scene extension with / without storage function for all 2 inputs ²)

Object:	Function:	Name:	Type:	Flag:
<input type="checkbox"/> 0 – 1	Light-scene extension	Input 1 – Input 2	1 byte	C, W, (R) ¹

Function: Binary input / "Value transmitter" (Function: Temperature value transmitter for all 2 inputs ²)

Object:	Function:	Name:	Type:	Flag:
<input type="checkbox"/> 8 – 9	Temperature value	Input 1 – Input 2	2 byte	C, W, (R) ¹

Function: Binary input / "Value transmitter" (Function: Brightness value transmitter for all 2 inputs ²)

Object:	Function:	Name:	Type:	Flag:
<input type="checkbox"/> 8 – 9	Brightness value	Input 1 – Input 2	2 byte	C, W, (R) ¹

Function: Binary input / "Pulse counter" (for inputs 1 ³)

Object:	Function:	Name:	Type:	Flag:
<input checked="" type="checkbox"/> 1	Sync signal pulse counter 1	Input 2	1 bit	C,W,T,(R) ¹
<input type="checkbox"/> 8	Pulse counter 1 status	Input 1	2 byte	C, T, (R) ¹

instabus EIB System

Sensor

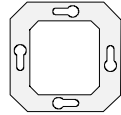

Function: Binary input / "Switching event counter" (for inputs 1 and 2³)

Object:	Function:	Name:	Type:	Flag:
□- 0	Switching event counter	Input 1	1 bit	C,W,T,(R) ¹
□- 1	Switching event counter	Input 2	1 bit	C,W,T,(R) ¹
□ 8	Switching event counter	Input 1	2 byte	C,T,(R) ¹
□ 9	Switching event counter	Input 2	2 byte	C,T,(R) ¹

Function: Disabling (for all 2 inputs⁴)

Object:	Function:	Name:	Type:	Flag:
□- 16 – 17	Disabling	Input 1 – Input 2	1 bit	C, T, (R) ¹

Function: Output (for all 2 outputs)

Object:	Function:	Name:	Type:	Flag:
□- 0 – 1	Switching	Output 1 - 2	1 bit	C, W, (R) ¹

Function: Additional function for outputs = "Logic-operation object" (for all 2 outputs)

Object:	Function:	Name:	Type:	Flag:
□- 8 – 9	Logic operation	Output 1 – 2	1 bit	C, W, (R) ¹

Function: Additional function for outputs = "Disabling object" (for all 2 outputs)

Object:	Function:	Name:	Type:	Flag:
□- 8 – 9	Disabling	Output 1 – 2	1 bit	C, W, (R) ¹

Function: Additional function for outputs = "Priority-position object" (for all 2 outputs)

Object:	Function:	Name:	Type:	Flag:
□- 8 – 9	Priority-position	Output 1 - 2	2 bit	C, W, (R) ¹

Function: Feedback for outputs (for all 2 outputs⁵)

Object:	Function:	Name:	Type:	Flag:
□ 16 – 17	Feedback	Output 1 - 2	1 bit	C, W, (R) ¹

- 1: Objects marked (R) permit read-out of the object status (set R flag).
- 2: The "No function", "Switching", "Dimming", "Shutter/blind" and "Value transmitter" functions can be selected per input. The names of the communication objects and the object table (dynamic object structure) will change accordingly.
- 3: The "pulse counter" function can only be parameterized for input 1!
In these function the input 2 will be reserved for the sync signal. For this reason, input 2 must be parameterized as "Pulse counter / Sync input".
- 4: If the inputs have been parameterized for "No function", "Pulse counter" or "Switching counter", no Disabling function will be possible.

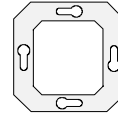

Functional description of binary inputs

Value transmitter by long key-press

In the even of value transmitter parameterization (value transmitter, temperature value transmitter or brightness value transmitter), the value to be transmitted can be changed by means of a long key-press (> 5 s) if the the value is to be transmitted on the rising or the falling edge. In this case, the programmed value is increased by the parameterized step width and transmitted. After releasing of the input contact, the value last transmitted remains stored. On the next long key-press, the direction of value change is reversed.

Example for dimming value transmitter 1 byte:

Value (0...255) 17
step width (1...10) 5

edge at input

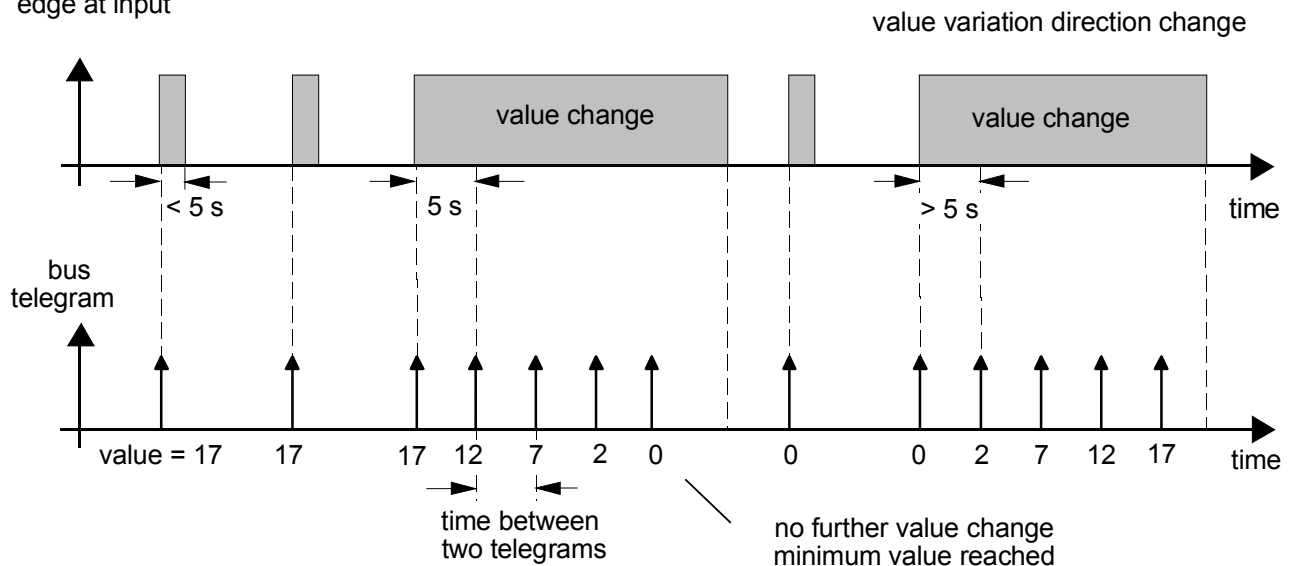

Important:

- During value change there is no overrun and no underrun. When the maximum (255) resp. the minimum (0) value is reached, no more telegrams are transmitted.
- To ensure that the concerned lighting switches off or on with the max. value during value change, the limit values (values "0" resp. "255") are always transmitted when the limits of the change range are reached. This is also the case when the parameterized step width does take these values directly into account (cf. example above: step width = 5; value "2" is transmitted, thereafter value "0"). To ensure that the original starting value can be set again during a new change (change of variation direction), the first value jump will not correspond to the preset step width (cf. example above: step width = 5; value "0" is transmitted, thereafter values "2", "7" etc.).
- When values are changed, the newly set values are stored in the RAM. After a bus voltage failure or a bus reset, the changed values will be replaced by the values originally parameterized in the ETS.

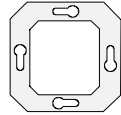

Light-scene extension with / without storage function

In a parameterization as light-scene extension without storage function it is possible to recall a light-scene. In case of a rising edge, a falling edge or a rising and falling edge, the parameterized light-scene number is transmitted immediately.

In a parameterization as light-scene extension with storage function it is possible to generate a storage telegram depending on the light-scene to be transmitted. A long actuation of the n.o. contact (rising edge) or of the n.c. contact (falling edge) causes the corresponding storage telegram to be transmitted. In this case, the time for a long press is parameterizable (however not below 5 s). After a short press < 1 s, the parameterized light-scene number (without storage telegram) is transmitted. If the actuation is longer than 1 s, but shorter than 5 s, no telegram will be transmitted. In addition, it is possible to transmit only a storage telegram with preceding light-scene recall. In this case, the "Storage function only" parameter must be set to "YES".

Examples for light-scene extension with storage function:

- 1.) storage function only = NO
- 2.) storage function only = YES

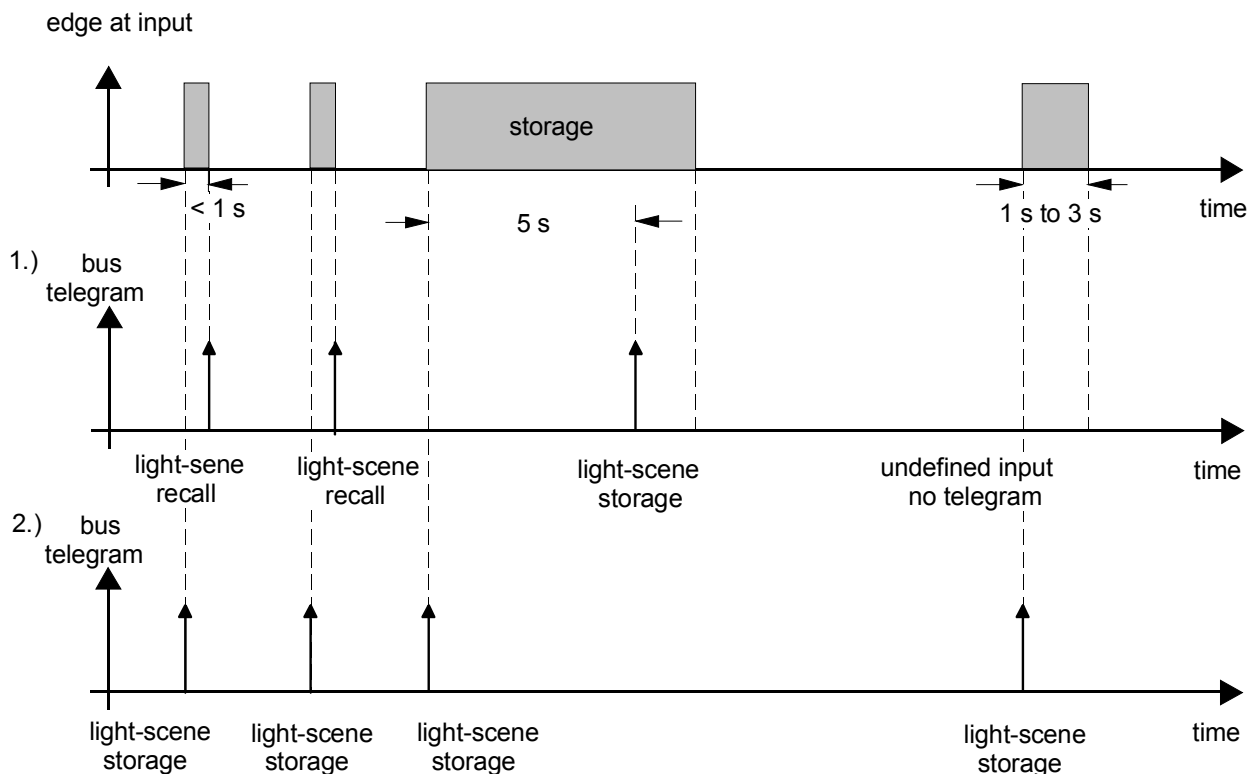

storage function only = NO:

If a rising or a falling edge is detected at the input (depending on parametrization), the timer is started. If the key is released within the first second, the corresponding light-scene is recalled immediately. If the key is pressed longer, the storage telegram is transmitted after 5 s.

storage function only = YES:

The storage telegram is transmitted immediately after detection of the corresponding edge.

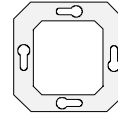

Pulse counter

The pulse counter can only be parameterized for input 1. In this case, input 2 is reserved for the sync signal. For this reason, input 2 must be parameterized as "pulse counter/sync input". If channel 1 is selected as output, it cannot be assigned any pulse counting function.

Pulse counter 1 has a resolution of 16 bits so that counts between 0 and 65535 are possible. The current counter status can be read out at object 8 by setting the R flag.

The counting pulse is applied to input 1. After the parameterized interval time has elapsed, the counter status will be taken over and sent as object value of the 2-byte "count" object (object 8). The 2-byte pulse counter will then be internally reset during the next time interval.

The current counter status in the count object can only be read out (set R flag) after a new edge at the input or after the newly started time interval has elapsed.

In addition, the counter status and the interval time can be reset by a sync signal at input 2. Switching telegrams (no telegram, ON, OFF, TOGGLE) can moreover be transmitted depending on the sync signal edge. The output value can be assigned to the edge. The edge assignment for resetting of the counter status can be parameterized independent of the output value.

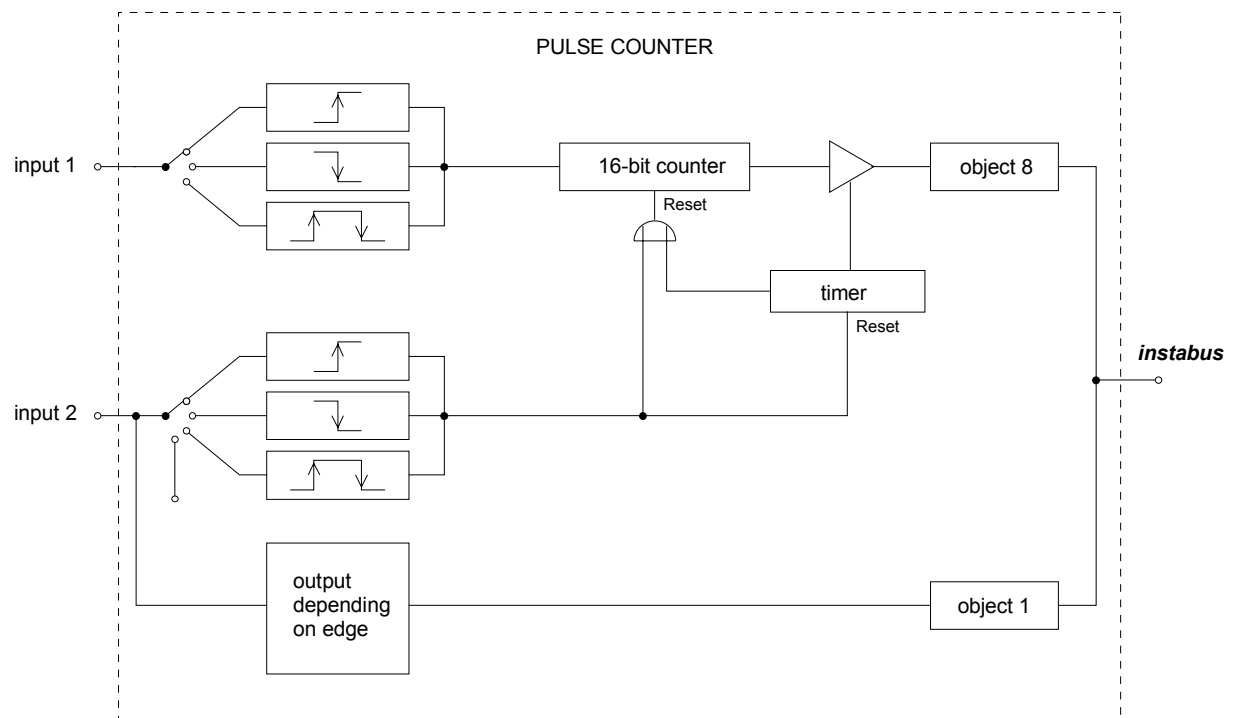

The pulse counter cannot be disabled.

The counter status is stored in the RAM. After a bus voltage failure or a bus reset, the value is deleted ("0").

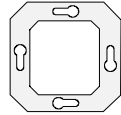

Switching event counter

The switching event counters can only be parameterized for inputs 1 or 2. If channels 1 or 2 are defined as outputs, no switching event counter functions can be implemented for these channels.

The switching event counters 1 and 2 run independently of each other and have a resolution of 16 bits so that counts between 0 and 65535 are possible. The current counter status can be read out at objects 8 or 9 by setting the R flag.

The counting pulse is applied to input 1 or 2, respectively. After the count has reached the parameterized default value, the counter status is taken over into the 2-byte object 8 resp. 9 and transmitted. In this case, a parameterizable signal value (1-bit-object "0" resp. "1") can be output. After the transmission, the 16-bit counter is automatically reset internally. The current count in the counter status objects can only be read out (set R flag) after a new edge at the input.

The counter status is additionally transmitted cyclically after a predefined number of counting pulses (1...255).

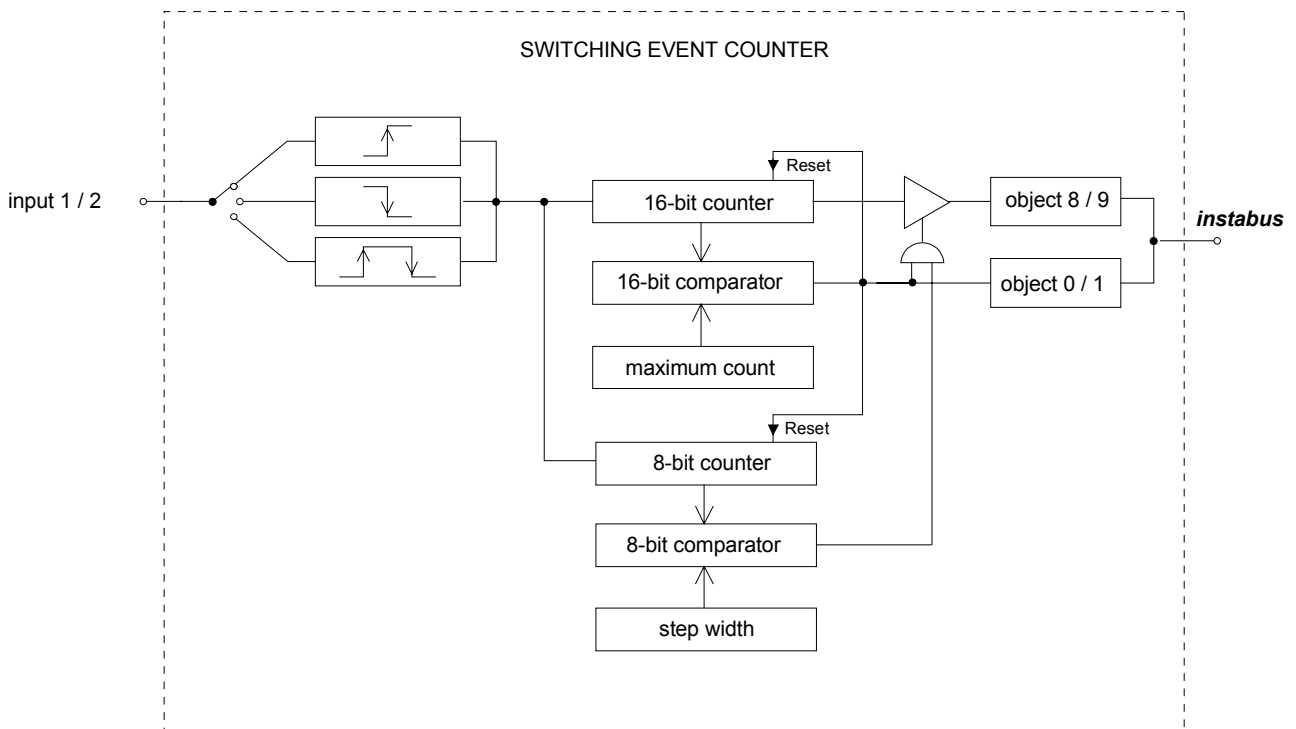

The switching event counter cannot be disabled.

The counts are stored in the RAM. After a bus voltage failure or a bus reset, the value is deleted ("0").

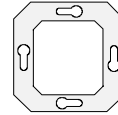

Response to return of bus voltage

It is possible to define separately for each input whether a reaction or what kind of reaction is to take place on return of bus voltage so that a defined telegram can be transmitted to the bus depending on the input signal or by forced control.

The defined reaction takes place only after the parameterized "Delay after bus voltage return" has elapsed. While the delay is active, any edges or signals present at the inputs are not evaluated and discarded. The delay is generally parameterized for all inputs and also for the outputs.

It is possible to parameterize a general telegram rate limitation. In this case, no telegram is transmitted within the first 17 s after bus voltage return.

It should be noted that the parameterized "Delay on return of bus voltage" is active also during this time and that the parameterized reaction on bus voltage return is not executed if the delay lies within the first 17 seconds.

Disabling function

Each input can be independently configured for a certain reaction at the beginning or at the end of disabling. It is also possible to parameterize the input for "No reaction". Only in this case will dimming or shutter control procedures or value changes in progress before activation of the disabling function continue to be executed until the end when disable is active. In all other cases, the parameterized command will be transmitted immediately at the beginning of disabling. During an active disable, edges or signals at the corresponding inputs are not evaluated.

Updates on disabling objects (disable or enable) will always lead to the transmission of the corresponding command parameterized for "the beginning resp. the end of disabling".

During an active disable, no cyclical transmission takes place to the disabled input.

If cyclical transmission did take place before activation of the disabling function, no cyclical transmission will take place anymore at the end of disabling when "No reaction" is parameterized. In this case, the object value will again be transmitted cyclically only after an update on the switching object. In all other cases, the object value will again be transmitted cyclically after the end of disabling.

Cyclical transmission

The object value transmitted is always the object value internally or externally followed up in the switching objects. For this reason, the object value is transmitted cyclically even if "No reaction" is assigned to a rising or a falling edge.

Cyclical transmission takes place also directly after the return of bus voltage, if the parameterized value of the telegram after bus voltage return corresponds to the object value parameterization for cyclical transmission. If telegram rate limitation is enabled, cyclical transmission will take place at the earliest after 17 seconds.

During an active disable, no cyclical transmission takes place via the disabled input.

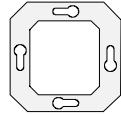

Functional description for LED outputs

Response to return of bus voltage

The preferred state of a switching output on return of bus voltage can be defined.

In this way, the switching output can be 'energized' (setting: "Close contact" / LED on) or 'deenergized' (setting: "Open contact" / LED off). The "Mode" parameter (normally open or normally closed) is irrelevant in this case.

The switching state that was active before bus voltage failure (setting: "Value before bus voltage failure") can moreover be followed up. Timer or other activated logic-operation functions which may have been started before bus voltage failure will not be accounted for.

The switching state set after return of bus voltage will be followed up only in the feedback object.

The defined response to bus voltage return will be triggered only after the parameterized "Delay on bus voltage return" has elapsed. Within the delay period, the outputs show no reaction. Updates of the switching objects via the bus during the delay period will be stored and executed only after the end of the delay.

It is possible to parameterize a general telegram rate limitation. In this case, no telegram will be transmitted via the feedback objects within the first 17 s after bus voltage return.

The switching outputs can nevertheless be actuated via the switching objects as soon as the "Delay on bus voltage return" has elapsed.

In the event of bus voltage failure, the outputs will always switch off (LED off).

A disabling function or a priority position activated before bus voltage failure is always deactivated after return of bus voltage.

Feedback object

When the switching state of an output changes, the current switching state is transmitted to the bus via the corresponding feedback object.

The feedback object value is updated also after return of bus voltage when the parameterized delay period has elapsed and is actively transmitted to the bus. With telegram rate limitation being enabled, no telegram will be transmitted via the feedback objects within the first 17 s. The feedback signal is stored and then executed after the 17 s delay has elapsed.

It may be possible to read out the object status by means of a display software (set R flag!).

The switching status set after return of bus voltage will only be followed up in the feedback object so that the switching object is not updated.

Flashing output signals

If desired, the output signal of a switching output may be in a flashing mode when the LED is on (contact closed). The flashing function can be activated separately for both switching outputs.

The flashing frequency can be preset in three steps:

- fast (approx. 9 Hz)
- medium (approx. 4 Hz)
- slow (approx. 1 Hz).

Synchronous flashing of both outputs cannot be guaranteed.

To increase the total output current (cf. technical data), both switching outputs can be connected in parallel, if they have the same parameterization. When connected in parallel in this way, the output channels cannot be operated in the flashing mode.

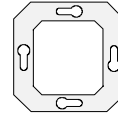

Additional functions

Priority-position object:

The priority-position object can be used to force a switching output by means of 2-bit telegrams independently of the switching object separately into a switching position. The "Mode" parameter remains effective in this case, too. The value of the 2-bit telegram must have the following syntax:

Bit 1	Bit 0	Function
0	x	Priority not active, \Rightarrow 'switching' object
0	x	Priority not active, \Rightarrow 'switching' object
1	0	Priority active switching off
1	1	Priority active switching on

The first bit (bit 0) of the priority-position object determines the switching state to be forced on the output. The second bit (bit 1) of the priority-position object enables the priority-position mode.

When the priority-position mode is active (priority), any incoming switching telegrams will still be evaluated internally. When the priority-position mode is thereafter no longer active (priority), the current internal switching state will be set depending on the value of the switching object.

A priority-position mode that was active before bus voltage failure will always be inactive after return of bus voltage.

Logic-operation object:

If the logic-operation object has been parameterized, it is possible to implement a logic operation on the switching object of the corresponding output. In this case, the object values of the logic-operation object and of the switching object are combined by means of the "AND" / "OR" / "AND with feedback" operations. Depending on the result of these logic operations, the output will be activated or not.

AND with feedback:

With a logic-operation object = "0" the output is always "0" (logic AND). In this case, the feedback of the output to the switching object, resets the switching object when it is being set. Only if the logic-operation object = "1", can the output pass to logic state "1" after a newly received "1" on the switching object.

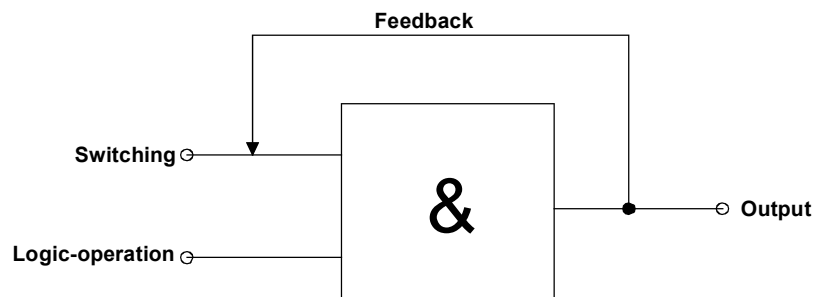

Sensor

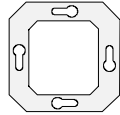

Disabling object:

If the disabling object has been parameterized, an assigned output can be locked in a parameterizable switching position after reception of a disable telegram. The polarity of the disabling object can be preselected.

When the disabling function is activated or deactivated, the response of the output can be predefined for both cases. The output can either switch on or switch off. The "Mode" parameter must be taken into account in this case.

Examples:

Mode = "n.o. contact", command "Switch off" → output supplying no current,

Mode = "n.o. contact", command "Switch on" → output supplying current,

Mode = "n.c. contact", command "Switch off" → output supplying current,

Mode = "n.c. contact", command "Switch on" → output supplying no current

In the "No change" setting, the switching status before the disabling function or the switching status set by the disabling function is retained. During an active disabling function, telegrams received via the switching object will be discarded. A disabling function that was active before bus voltage failure will always be inactive after return of bus voltage.

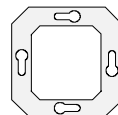

Parameters			
Description:	Values:		Comment:
Function			
Function channel 1	binary input output (LED max. 0.8 mA)		Defines the function of the first channel.
Channel 1: Output signal flashing?	YES NO		Defines whether the output signal of a switching output flashes or not. Only if "Function channel 1 = output"
Flashing frequency	slow (approx. 1 Hz) medium (approx. 4 Hz) fast (approx. 9 Hz)		Defines the flashing frequency of the output signal. Only if "Channel 1: output signal flashing = YES"
Function channel 2	binary input output (LED max. 0.8 mA)		Defines the function of the second channel.
Channel 2: Output signal flashing?	YES NO		Defines whether the output signal of a switching output flashes or not. Only if "Function channel 2 = output"
Flashing frequency	slow (approx. 1 Hz) medium (approx. 4 Hz) fast (approx. 9 Hz)		Defines the flashing frequency of the output signal. Only if "Channel 2: output signal flashing = YES"
General			
Delay on return of bus voltage Base	130 ms 260 ms 520 ms 1 s 2,1 s 4,2 s 8,4 s 17 s	34 s 1,1 min 2,2 min 4,5 min 9 min 18 min 35 min 1,2 h	After return of bus voltage, the application program of the push button interface can be disabled for a defined period of time before the corresponding reactions take place. During this time, no signals present on the inputs will be evaluated and the switching outputs will not be activated either. Even a feedback signal cannot be expected before the delay has elapsed. Defines the time base of the delay period. Time = Base · Factor

instabus EIB System

Sensor

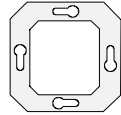

General		
Delay on return of bus voltage Factor (3...127)	3 to 127, 17	Defines the time factor of the delay period. $\text{Time} = \text{Base} \cdot \text{Factor}$ Presetting: $1 \text{ s} \cdot 17 = 17 \text{ s}$
Debouncing time for binary inputs Factor (10...255) * 0.5 ms	0 to 255, 60	Defines the software debouncing time in common for all binary inputs. A signal edge at the input will be evaluated with a delay corresponding to the time defined. $\text{Time} = 0.5 \text{ ms} \cdot \text{Factor}$ Presetting: $0.5 \text{ ms} \cdot 20 = 10 \text{ ms}$
Telegram rate limitation	enabled disabled	The telegram rate limitation can be enabled or disabled. When the telegram rate limitation is enabled, no telegrams will be transmitted in the first 17 s after bus voltage return.
Telegrams per 17 s	30 60 100 127	When the telegram rate limitation is enabled, the maximum number of telegrams in 17 s can be preset here.
Input 1 (only if "Function channel 1 = binary input")		
Function channel 1	no function switching dimming shutter/blind value transmitter pulse counter switching event counter	Defines the function of input 1.
Function of input 1 = "No function"		
		No further parameters
Function of input 1 = "Switching"		
Command on rising edge Switching object 1.1	no reaction ON OFF TOGGLE	Defines the command transmitted via switching object 1.1 on the rising edge. "TOGGLE" toggles the object value.
Command on falling edge Switching object 1.1	no reaction ON OFF TOGGLE	Defines the command transmitted via switching object 1.1 on the falling edge. "TOGGLE" toggles the object value.

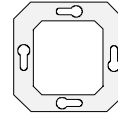

Input 1 (only if "Function channel 1 = binary input")		
Function of input 1 = "Switching"		
Command on rising edge Switching object 1.2	no reaction ON OFF TOGGLE	Defines the command transmitted via switching object 1.2 on the rising edge. "TOGGLE" toggles the object value.
Command on falling edge Switching object 1.2	no reaction ON OFF TOGGLE	Defines the command transmitted via switching object 1.2 on the falling edge. "TOGGLE" toggles the object value.
Response to bus voltage return	no reaction transmit current input status transmit ON telegram transmit OFF telegram	Permits defining the reaction that is to take place after return of bus voltage. The parameterized delay after return of bus voltage must have elapsed before the reaction defined will be executed. No reaction. The current input state corresponding to the parameterization for rising and falling edge is transmitted. Transmits an ON signal. Transmits an OFF signal.
Cyclical transmission?	no cyclical transmission repeat when ON repeat when OFF repeat when ON and OFF	Cyclical transmission can be realized via the switching objects depending on the object value. No cyclical transmission. Cyclical transmission active when the object value is "ON". Cyclical transmission active when the object value is "OFF". Cyclical transmission always active independent of object value.
Time base for cyclical transmission Switching object 1.1	1 s 1,1 min 2,1 s 2,2 min 4,2 s 4,5 min 8,4 s 9 min 17 s 18 min 34 s 35 min 1,1 min 1,2 h 34 s	Defines the time base for cyclical transmission via switching object 1.1. Time = Base · Factor

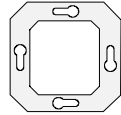

Input 1 (only if "Function channel 1 = binary input")		
Function of input 1 = "Switching"		
Time base for cyclical transmission Switching object 1.2	1 s 1.1 min 2.1 s 2.2 min 4.2 s 4.5 min 8.4 s 9 min 17 s 18 min 34 s 35 min 1.1 min 1.2 h 34 s no cyclical transmission via switching object X.2	Defines the time base for cyclical transmission via switching object 1.2. Cyclical transmission via switching object 1.2 can be disabled when "No cyclical transmission via switching object X.2" is selected. Time = Base · Factor
Time base for cyclical transmission Switching object 1.1 and 1.2 Factor (3...127)	3 to 127, 60	Defines the time base for cyclical transmission via both switching objects. Time = Base · Factor Presetting: 1 s · 60 = 60 s
Input 1, Disabling (HA)		
Disabling function (HA)	enabled disabled	The Disabling function can be enabled or disabled .
Disabling object polarity (HA)	disabled = 1 (enable = 0) disabled = 0 (enable = 1)	This parameter defines the polarity of the disabling object.
Response at the beginning of disabling Switching objects 1.1 and 1.2 (HA)	no reaction ON OFF TOGGLE	When disabling is active, both switching objects are disabled . This parameter defines the command transmitted at the beginning of disabling via both switching objects. "TOGGLE" toggles the object values.
Response at the end of disabling Switching objects 1.1 and 1.2 (HA)	no reaction ON OFF transmit current input status	When disabling is active, both switching object are disabled . This parameter defines the command transmitted at the end of disabling via both switching objects. When the value is "Transmit current input status", the current input status will be transmitted corresponding to the parameterization for the rising and the falling edge.

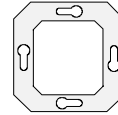

Input 1 (only if "Function channel 1 = binary input")		
Function of input 1 = "Dimming"		
Operation	<p>single-button operation: brighter / darker (TOGGLE)</p> <p>double-button operation: brighter (ON)</p> <p>double-button operation: darker (OFF)</p> <p>double-button operation: brighter (TOGGLE)</p> <p>double-button operation: darker (TOGGLE)</p>	<p>Defines the response to a rising edge on the input.</p> <p>After a brief press of the button at the input, the object value of the switching object is toggled and a corresponding telegram transmitted. A long press triggers a dimming telegram (brighter / darker). The dimming direction is stored only internally and toggled for successive dimming cycles.</p> <p>A short press of the button on the input sends an ON telegram, whereas a long press triggers a dimming telegram (brighter).</p> <p>A short press of the button on the input sends an OFF telegram, whereas a long press triggers a dimming telegram (brighter).</p> <p>A short press of the button on the input toggles the object value of the switching object and sends a corresponding telegram, whereas a long press triggers a dimming telegram (brighter).</p> <p>A short press of the button on the input toggles the object value of the switching object and sends a corresponding telegram, whereas a long press triggers a dimming telegram (darker).</p>
Time between switching and dimming Base	130 ms 260 ms 520 ms 1 s	Time after which the dimming function is executed ("long press"). Time = Base · Factor
Time between switching and dimming Factor (4...127)	4 to 127, 4	Time after which the dimming function is executed ("long press"). Time = Base · Factor Presetting: 130 ms · 4 = 520 ms

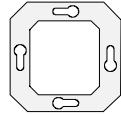

Input 1 (only if "Function channel 1 = binary input")		
Funktion des Eingangs 1 = "Dimmen"		
Response to bus voltage return	<p>no reaction</p> <p>transmit ON telegram</p> <p>transmit OFF telegram</p>	<p>The reaction taking place after bus voltage return can be defined.</p> <p>If a delay after bus voltage return is parameterized, this delay must have elapsed before the defined reaction will take place.</p> <p>No reaction.</p> <p>Transmits an ON signal.</p> <p>Transmits an OFF signal.</p>
Increase brightness by	<p>100 % 6 %</p> <p>50 % 3 %</p> <p>25 % 1,5 %</p> <p>12,5 %</p>	<p>A dimming telegram permits increasing the brightness by a max. value of X %. This parameter defines the max. dimming step width of a dimming telegram.</p> <p>The parameter is independent of the operation preset.</p>
Reduce brightness by	<p>100 % 6 %</p> <p>50 % 3 %</p> <p>25 % 1,5 %</p> <p>12,5 %</p>	<p>A dimming telegram permits reducing the brightness by a max. value of X %. This parameter defines the max. dimming step width of a dimming telegram.</p> <p>This parameter is independent of the operation preset.</p>
Transmit stop telegram?	<p>YES</p> <p>NO</p>	<p>When a button on the input is released (falling edge), a stop telegram is transmitted or not.</p>
Repeat telegram ?	<p>YES</p> <p>NO</p>	<p>Cyclical repetition of dimming telegrams during a long press.</p>
Time between two telegrams Base	<p>130 ms</p> <p>260 ms</p> <p>520 ms</p> <p>1 s</p>	<p>Time between two telegrams when telegram repetition is selected.</p> <p>After this time, a new telegram will be sent. Only if "Repeat telegram ?" = "YES".</p> <p>Time = Base · Factor</p>
Time between two telegrams Factor (3...127)	<p>3 to 127, 10</p>	<p>Time between two telegrams when telegram repetition is selected.</p> <p>After this time, a new dimming telegram will be sent. Only if "Repeat telegram ?" = "YES".</p> <p>Time = Base · Factor</p> <p>Presetting: 130 ms · 10 = 1.3 s</p>

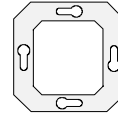

Input 1, Disabling (HA)		
Disabling function (HA)	enabled disabled	The Disabling function can be enabled or disabled.
Disabling object polarity (HA)	disable = 1 (enable = 0) disable = 0 (enable = 1)	This parameter defines the polarity of the disabling object.
Response at the beginning of disabling (HA)	no reaction ON OFF TOGGLE	This parameter defines the command transmitted at the beginning of disabling via the switching object. "TOGGLE" toggles the object values.
Response at the end of disabling (HA)	no reaction OFF	This parameter defines the command transmitted at the end of disabling via the switching object.
Input 1 (only if "Function channel 1 = binary input")		
Function of input 1 = "Shutter/blind"		
Command on rising edge	no function UP DOWN TOGGLE	Defines the response to a rising edge at the input. Input deactivated. A brief press triggers a STEP telegram (UP), a long press triggers a MOVE telegram (up). A brief press triggers a STEP telegram (DOWN), a long press triggers a MOVE telegram (down). This setting toggles the travel direction internally for each long press (MOVE). When a STEP telegram is transmitted by a brief press, this STEP always occurs in opposite direction to the last MOVE. Several successive STEP telegrams occur in the same direction.
Response to bus voltage return	no reaction UP DOWN	The reaction taking place after bus voltage return can be defined. If a delay after bus voltage return is parameterized, this delay must have elapsed before the defined reaction will take place. No reaction. Transmits a MOVE (UP) command. Transmits a MOVE (DOWN) command.

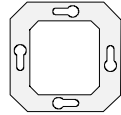

<p> Input 1 (only if "Function channel 1 = binary input")</p> <p> Function of input 1 = "Shutter/blind"</p>	
<p>Operating concept</p>	<p>step – move - step</p> <p>Defines the telegram sequence after a key-press (rising edge).</p> <p>Step - move - step:</p> <p>A rising edge sends a STEP and time T1 (time between short- and MOVE operation) is started. This STEP serves the purpose of stopping a continuous run. If a falling edge is detected within T 1, the binary input sends no further telegram.</p> <p>If no falling edge has been detected during T 1, the binary input automatically sends a MOVE after T1 and time T 2 is started (slat adjusting time). If a falling edge is then detected within T 2, the binary input sends a STEP. This function is used for the adjustment of the slats. T2 should correspond to the time required for a slat rotation through 180°.</p> <p>move - step</p> <p>Move - step:</p> <p>A rising edge at the input sends a MOVE and time T1 (slat adjusting time) is started. If a falling edge is detected within T 1, the binary input sends a STEP. This function is used for the adjustment of the slats. T1 should correspond to the time needed for a slat rotation through 180°.</p>

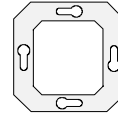

Input 1 (only if "Function channel 1 = binary input")			
Function of input 1 = "Shutter/blind"			
Time between STEP and MOVE operation Base	130 ms 260 ms 520 ms 1 s 2,1 s 4,2 s	8,4 s 17 s 34 s 1,1 min 34 s	Time after which the MOVE operation function is executed Only with operating concept = "Step - move - step" Time = base · factor
Time between STEP and MOVE operation Factor (4...127)	4 to 127, 4		Time after which the MOVE operation function is executed Only with operating concept = "Step - move - step" Time = base · factor Presetting: 130 ms · 4 = 520 ms
Slat adjustment time Base	130 ms 260 ms 520 ms 1 s 2,1 s 4,2 s	8,4 s 17 s 34 s 1,1 min 34 s	Time during which a MOVE telegram for slat adjustment can be terminated by releasing the push button at the input Time = base · factor
Slat adjustment time Factor (3...127)	3 to 127, 20		Time during which a MOVE telegram for slat adjustment can be terminated by releasing the push button at the input Time = base · factor Presetting: 130 ms · 20 = 2.6 s
Input 1, Disabling (HA)			
Disabling function (HA)	enabled disabled		The Disabling function can be enabled or disabled.
Disabling object polarity (HA)	disable = 1 (enable = 0) disable = 0 (enable = 1)		This parameter defines the polarity of the disabling object.
Response at the beginning of disabling (HA)	no reaction ON OFF TOGGLE		This parameter defines the command transmitted at the beginning of disabling via the MOVE object. "TOGGLE" toggles the running direction last executed (stored internally).
Response at the end of disabling (HA)	no reaction ON OFF TOGGLE		This parameter defines the command transmitted at the end of disabling via the MOVE object. "TOGGLE" toggles the running direction last executed (stored internally).

instabus EIB System

Sensor

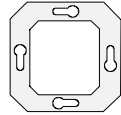

Input 1 (only if "Function channel 1 = binary input")		
Function of input 1 = "Value transmitter"		
Function as	dimming value transmitter light-scene recall without storage function light-scene recall with storage function temperature value transmitter brightness value transmitter	Defines the function to be executed.
Value transmitter function = "Dimming value transmitter"		
Transmit value	on rising edge (push button as n.o. contact) on falling edge (push button as n.c. contact) on rising and falling edge (switch)	Defines the edge triggered by a press.
Value on rising edge (0...255)	0 to 255, 100	Defines the value transmitted on a rising edge. Only if "Transmit value = on rising edge (push button as n.o. contact)" and "Transmit value = on rising and falling edge (switch)".
Value on falling edge (0...255)	0 to 255, 0	Defines the value transmitted on a falling edge. Only if "Transmit value = on falling edge (push button as n.c. contact)" and "Transmit value = on rising and falling edge (switch)".

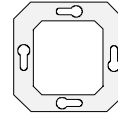

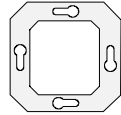

 Value transmitter function = "Dimming value transmitter"		
Response to bus voltage return	<p>no reaction</p> <p>reaction as with rising edge</p> <p>reaction as with falling edge</p> <p>transmit current input state</p>	<p>Permits defining the reaction that is to take place after return of bus voltage. If a delay after return of bus voltage has been parameterized, this delay must have elapsed before the reaction defined will be executed.</p> <p>No reaction</p> <p>The value parameterized for the rising edge will be transmitted.</p> <p>Only if "Transmit value = on rising edge (push button as n.o. contact)" and "Transmit value = on rising and falling edge (switch)".</p> <p>The value parameterized for the falling edge will be transmitted.</p> <p>Only if "Transmit value = on falling edge (push button as n.c. contact)" and "Transmit value = on rising and falling edge (switch)".</p> <p>The current state of the inputs corresponding to the parameterization for rising and falling edge will be transmitted.</p> <p>Only if "Transmit value = on rising and falling edge (switch)".</p>
Value change by long press?	<p>YES</p> <p>NO</p>	<p>With a long press (< 5 s), the current value can be cyclically reduced or increased by the parameterized step width (see below) and transmitted. After this value variation, the value last transmitted remains stored. The parameter defines whether a value change is possible.</p> <p>Only if "Transmit value = on rising edge (push button as n.o. contact)" and "Transmit value = on falling edge (push button as n.c. contact)"</p>
Time between two telegrams Base	<p>130 ms</p> <p>260 ms</p> <p>520 ms</p> <p>1 s</p>	<p>Time base for the time between two cyclical telegrams for value change.</p> <p>Only if "Value change by long press ?= YES"</p>

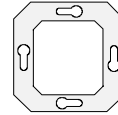

Value transmitter function = "Dimming value transmitter"		
Time between two telegrams Factor (3...127)	3 to 127, 3	Time factor for the time between two cyclical telegrams for value variation. Only if "Value change by long press ?= YES" Time = Base · Factor Presetting: 520 ms · 3 = 1.56 s
Step width (1...10)	1 to 10, 10	Width of the step by which the set value will be reduced or increased by a long press. Only if "Change value by long press ?= YES"
Input 1, Disabling (HA)		
Disabling function (HA)	enabled disabled	The Disabling function can be enabled or disabled.
Disabling object polarity (HA)	disable = 1 (enable = 0) disable = 0 (enable = 1)	This parameter defines the polarity of the disabling object.
Response at the beginning of disabling (HA)	no reaction reaction as with rising edge reaction as with falling edge transmit current input state	This parameter defines the reaction taking place at the beginning of disabling. No reaction The value parameterized for the rising edge will be transmitted. Only if "Transmit value = on rising edge (push button as n.o. contact)" and "Transmit value = on rising and falling edge (switch)". The value parameterized for the falling edge will be transmitted. Only if "Transmit value = on falling edge (push button as n.c. contact)" and "Transmit value = on rising and falling edge (switch)". The current state of the inputs corresponding to the parameterization for rising and falling edge will be transmitted. Only if "Transmit value = on rising and falling edge (switch)".



 Input 1, Disabling (HA)		
Response at the end of disabling (HA)	<p>no reaction</p> <p>reaction as with rising edge</p> <p>reaction as with falling edge</p> <p>transmit current input state</p>	<p>This parameter defines the reaction taking place at the end of disabling.</p> <p>No reaction</p> <p>The value parameterized for the rising edge will be transmitted.</p> <p>Only if "Transmit value = on rising edge (push button as n.o. contact)" and "Transmit value = on rising and falling edge (switch)"</p> <p>The value parameterized for the falling edge will be transmitted.</p> <p>Only if "Transmit value = on falling edge (push button as n.c. contact)" and "Transmit value = on rising and falling edge (switch)".</p> <p>The current state of the inputs corresponding to the parameterization for rising and falling edge will be transmitted.</p> <p>Only if "Transmit value = on rising and falling edge (switch)".</p>
 Function of input 1 = "Value transmitter"		
 Value transmitter function = "Light-scene extension without storage function"		
Transmit light-scene number	<p>on rising edge (push button as n.o. contact)</p> <p>on falling edge (push button as n.c. contact)</p> <p>on rising and falling edge (switch)</p>	Defines the edge triggered by a press.
Light-scene on rising edge (1...64)	1 to 64, 1	<p>Defines the light-scene transmitted on a rising edge.</p> <p>Only if "Transmit light-scene number = on rising edge (push button as n.o. contact)" and "Transmit value = on rising and falling edge (switch)"</p>
Light-scene on falling edge (1...64)	1 to 64, 1	<p>Defines the light-scene transmitted on a falling edge.</p> <p>Only if "Transmit light-scene number = on falling edge (push button as n.c. contact)" and "Transmit value = on rising and falling edge (switch)"</p>

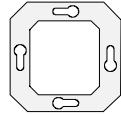

Value transmitter function = "Light-scene extension without storage function"		
Response to bus voltage return	<p>no reaction</p> <p>Reaction as with rising edge</p> <p>Reaction as with falling edge</p> <p>Transmit current input state</p>	<p>Permits defining the reaction that is to take place after return of bus voltage. If a delay after return of bus voltage has been parametrized, this delay must have elapsed before the reaction defined will be executed.</p> <p>No reaction</p> <p>The value parameterized for the rising edge will be transmitted.</p> <p>Only if "Transmit light-scene number = on rising edge (push button as n.o. contact)" and "Transmit light-scene number = on rising and falling edge (switch)"</p> <p>The light-scene parameterized for the falling edge will be transmitted.</p> <p>Only if "Transmit light-scene number = on falling edge (push button as n.c. contact)" and "Transmit light-scene number = on rising and falling edge (switch)"</p> <p>The current state of the inputs corresponding to the parameterization for rising and falling edge will be transmitted.</p> <p>Only if "Transmit light-scene number = on rising and falling edge (switch)"</p>
Input 1, Disabling (HA)		
Disabling function (HA)	<p>enabled</p> <p>disabled</p>	The Disabling function can be enabled or disabled.
Disabling object polarity (HA)	<p>disable = 1 (enable = 0)</p> <p>disable = 0 (enable = 1)</p>	This parameter defines the polarity of the disabling object.

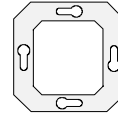

 Input 1, Disabling (HA)		
Response at the beginning of disabling (HA)	<p>no reaction</p> <p>reaction as with rising edge</p> <p>reaction as with falling edge</p> <p>transmit current input state</p>	<p>This parameter defines the reaction taking place at the beginning of disabling.</p> <p>No reaction</p> <p>The value parameterized for the rising edge will be transmitted.</p> <p>Only if "Transmit value = on rising edge (push button as n.o. contact)" and "Transmit value = on rising and falling edge (switch)"</p> <p>The value parameterized for the falling edge will be transmitted.</p> <p>Only if "Transmit value = on falling edge (push button as n.c. contact)" and "Transmit value = on rising and falling edge (switch)""!</p> <p>The current state of the inputs corresponding to the parameterization for rising and falling edge will be transmitted.</p> <p>Only if "Transmit value = on rising and falling edge (switch)".</p>
Response at the end of disabling (HA)	<p>no reaction</p> <p>reaction as with rising edge</p> <p>reaction as with falling edge</p> <p>transmit current input state</p>	<p>This parameter defines the reaction taking place at the end of disabling.</p> <p>No reaction</p> <p>The value parameterized for the rising edge will be transmitted.</p> <p>Only if "Transmit value = on rising edge (push button as n.o. contact)" and "Transmit value = on rising and falling edge (switch)"</p> <p>The value parameterized for the falling edge will be transmitted.</p> <p>Only if "Transmit value = on falling edge (push button as n.c. contact)" and "Transmit value = on rising and falling edge (switch)".</p> <p>The current state of the inputs corresponding to the parameterization for rising and falling edge will be transmitted.</p> <p>Only if "Transmit value = on rising and falling edge (switch)".</p>

instabus EIB System

Sensor

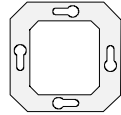

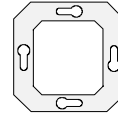

Function of input 1 = "Value transmitter"		
Value transmitter function = "Light-scene extension with storage function"		
Transmit light-scene number	on rising edge (push button as n.o. contact) on falling edge (push button as n.c. contact)	Defines the edge triggered by a press.
Light-scene on rising edge (1...64)	1 to 64, 1	Defines the light-scene transmitted on a rising edge. Only if "Transmit light-scene number = on rising edge (push button as n.o. contact)"
Light-scene on falling edge (1...64)	1 to 64, 1	Defines the light-scene transmitted on a falling edge. Only if "Transmit light-scene number = on falling edge (push button as n.c. contact)"
Response to bus voltage return	no reaction Reaction as with rising edge reaction as with falling edge	Permits defining the reaction that is to take place after return of bus voltage. If a delay after return of bus voltage has been parametrized, this delay must have elapsed before the reaction defined will be executed. No reaction The light-scene parameterized for the rising edge will be transmitted. Only if "Transmit light-scene number = on rising edge (push button as n.o. contact)" Defines the light-scene transmitted on a falling edge. Only if "Transmit light-scene number = on falling edge (push button as n.c. contact)"
Storage function only ?	YES NO	It is possible to send only a storage telegram without preceding light-scene recall.
Time of a long press for storage Base	130 ms ¹⁾ 260 ms ²⁾ 520 ms ³⁾ 1 s ⁴⁾	Time base for the time of a long press to transmit a storage telegram. Only if "Storage function only? = NO" Time = Base · Factor



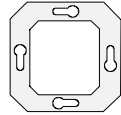

Value transmitter function = "Light-scene extension with storage function"		
Time of a long press for storage Factor (24...127) ¹⁾ Factor (13...127) ²⁾ Factor (9...127) ³⁾ Factor (4...127) ⁴⁾	24 to 127, 38 ¹⁾ 13 to 127, 19 ²⁾ 9 to 127, 10 ³⁾ 4 to 127, 5 ⁴⁾	Time factor for the time of a long press to transmit a storage telegram Only if "Storage function only? = NO" Time = Base · Factor Presetting: 520 ms · 10 = 5.2 s Important: The factor range depends on the selected base. Therefore, only times > 3 s can be parameterized.
Input 1, Disabling (HA)		
Disabling function (HA)	enabled disabled	The Disabling function can be enabled or disabled.
Disabling object polarity (HA)	disable = 1 (enable = 0) disable = 0 (enable = 1)	This parameter defines the polarity of the disabling object.
Response at the beginning of disabling (HA)	no reaction reaction as with rising edge reaction as with falling edge	This parameter defines the reaction taking place at the beginning of disabling. No reaction The value parameterized for the rising edge will be transmitted. Only if "Transmit value = on rising edge (push button as n.o. contact)" The value parameterized for the falling edge will be transmitted. Only if "Transmit value = on falling edge (push button as n.c. contact)"
Response at the end of disabling (HA)	no reaction reaction as with rising edge reaction as with falling edge	This parameter defines the reaction taking place at the end of disabling. No reaction The value parameterized for the rising edge will be transmitted. Only if "Transmit value = on rising edge (push button as n.o. contact)" The value parameterized for the falling edge will be transmitted Only if "Transmit value = on falling edge (push button as n.c. contact)"

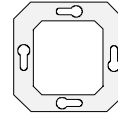

 Function of input 1 = "Value transmitter"		
 Value transmitter function = "Temperature value transmitter"		
Transmit value	on rising edge (push button as n.o. contact) on falling edge (push button as n.c. contact) on rising and falling edge (switch)	Defines the edge triggered by a press.
Value on rising edge	0 to 40 °C in 1 °C steps, 20 °C	Defines the temperature value to be transmitted. Only if "Transmit value = on rising edge (push button as n.o. contact)" and "Transmit value = on rising and falling edge (switch)".
Value on falling edge	0 to 40 °C in 1 °C steps, 18 °C	Defines the temperature value to be transmitted Only if "Transmit value = on falling edge (push button as n.c. contact)" and "Transmit value = on rising and falling edge (switch)".
Response to bus voltage return	<p>no reaction</p> <p>reaction as with rising edge</p> <p>reaction as with falling edge</p> <p>transmit current input state</p>	<p>Permits defining the reaction that is to take place after return of bus voltage. If a delay after return of bus voltage has been parametrized, this delay must have elapsed before the reaction defined will be executed.</p> <p>No reaction</p> <p>The value parameterized for the rising edge will be transmitted. Only if "Transmit value = on rising edge (push button as n.o. contact)" and "Transmit value = on rising and falling edge (switch)"</p> <p>The value parameterized for the falling edge will be transmitted. Only if "Transmit value = on falling edge (push button as n.c. contact)" and "Transmit value = on rising and falling edge (switch)".</p> <p>The current state of the inputs corresponding to the parameterization for rising and falling edge will be transmitted. Only if "Transmit value = on rising and falling edge (switch)".</p>



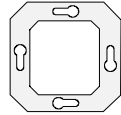

 Value transmitter function = "Temperature value transmitter"		
Value change by long press?	YES NO	With a long press (< 5 s), the current value can be cyclically reduced or increased by the parameterized step width (see below) and transmitted. After this value change, the value last transmitted remains stored. The parameter defines whether a value change is possible. Only if "Transmit value = on rising edge (push button as n.o. contact)" and "Transmit value = on falling edge (push button as n.c. contact)"
Time between two telegrams Base	130 ms 260 ms 520 ms 1 s	Time base for the time between two cyclical telegrams for value change. Only if "Change value by long press ?= YES" Time = Base · Factor
Time between two telegrams Factor (3...127)	3 to 127, 3	Time factor for the time between two cyclical telegrams for value variation. Only if "Change value by long press ?= YES" Time = Base · Factor Presetting: 520 ms · 3 = 1.56 s
Step width	1 °C	Width of the step by which the set value will be reduced by a long press.
 Input 1, Disabling (HA)		
Disabling function (HA)	enabled disabled	The Disabling function can be enabled or disabled.
Disabling object polarity (HA)	disable = 1 (enable = 0) disable = 0 (enable = 1)	This parameter defines the polarity of the disabling object.

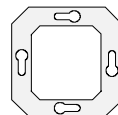

 Input 1, Disabling (HA)		
Response at the beginning of disabling (HA)	<p>no reaction</p> <p>reaction as with rising edge</p> <p>reaction as with falling edge</p> <p>transmit current input state</p>	<p>This parameter defines the reaction taking place at the beginning of disabling.</p> <p>No reaction</p> <p>The value parameterized for the rising edge will be transmitted. Only if "Transmit value = on rising edge (push button as n.o. contact)" and "Transmit value = on rising and falling edge (switch)".</p> <p>The value parameterized for the falling edge will be transmitted. Only if "Transmit value = on falling edge (push button as n.c. contact)" and "Transmit value = on rising and falling edge (switch)".</p> <p>The current state of the inputs corresponding to the parameterization for rising and falling edge will be transmitted. Only if "Transmit value = on rising and falling edge (switch)".</p>
Response at the end of disabling (HA)	<p>no reaction</p> <p>reaction as with rising edge</p> <p>reaction as with falling</p> <p>transmit current input state</p>	<p>This parameter defines the reaction taking place at the end of disabling.</p> <p>No reaction</p> <p>The value parameterized for the rising edge will be transmitted. Only if "Transmit value = on rising edge (push button as n.o. contact)" and "Transmit value = on rising and falling edge (switch)".</p> <p>The value parameterized for the falling edge will be transmitted. Only if "Transmit value = on falling edge (push button as n.c. contact)" and "Transmit value = on rising and falling edge (switch)".</p> <p>The current state of the inputs corresponding to the parameterization for rising and falling edge will be transmitted. Only if "Transmit value = on rising and falling edge (switch)".</p>



 Function of input 1 = "Value transmitter"		
 Value transmitter function = "Brightness value transmitter"		
Transmit value	on rising edge (push button as n.o. contact) on falling edge (push button as n.c. contact) on rising and falling edge (switch)	Defines the edge triggered by a press.
Value on rising edge	0 to 1500 lux in 50 lux steps, 200 lux	Defines the brightness value to be transmitted. Only if "Transmit value = on rising edge (push button as n.o. contact)" and "Transmit value = on rising and falling edge (switch)".
Value on falling edge	0 to 1500 lux in 50 lux steps, 0 lux	Defines the temperature value to be transmitted Only if "Transmit value = on falling edge (push button as n.c. contact)" and "Transmit value = on rising and falling edge (switch)".
Response to bus voltage return	<p>no reaction</p> <p>reaction as with rising edge</p> <p>reaction as with falling edge</p> <p>transmit current input state</p>	Permits defining the reaction that is to take place after return of bus voltage. If a delay after return of bus voltage has been parametrized, this delay must have elapsed before the reaction defined will be executed.
		<p>No reaction</p> <p>The value parameterized for the rising edge will be transmitted.</p> <p>Only if "Transmit value = on rising edge (push button as n.o. contact)" and "Transmit value = on rising and falling edge (switch)"</p> <p>The value parameterized for the falling edge will be transmitted.</p> <p>Only if "Transmit value = on falling edge (push button as n.c. contact)" and "Transmit value = on rising and falling edge (switch)".</p> <p>The current state of the inputs corresponding to the parameterization for rising and falling edge will be transmitted.</p> <p>Only if "Transmit value = on rising and falling edge (switch)".</p>

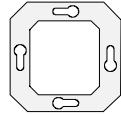

Value transmitter function = "Brightness value transmitter"		
Value change by long press?	YES NO	With a long press (< 5 s), the current value can be cyclically reduced or increased by the parameterized step width (see below) and transmitted. After this value change, the value last transmitted remains stored. The parameter defines whether a value change is possible. Only if "Transmit value = on rising edge (push button as n.o. contact)" and "Transmit value = on falling edge (push button as n.c. contact)"
Time between two telegrams Base	130 ms 260 ms 520 ms 1 s	Time base for the time between two cyclical telegrams for value change. Only if "Change value by long press ?= YES" Time = Base · Factor
Time between two telegrams Factor (3...127)	3 to 127, 3	Time factor for the time between two cyclical telegrams for value change. Only if "Change value by long press ?= YES" Time = Base · Factor Presetting: 520 ms · 3 = 1.56 s
Step width	50 lux	Width of the step by which the set value will be reduced by a long press.
Input 1, Disabling (HA)		
Disabling function (HA)	enabled disabled	The Disabling function can be enabled or disabled.
Disabling object polarity (HA)	disable = 1 (enable = 0) disable = 0 (enable = 1)	This parameter defines the polarity of the disabling object.

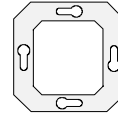

 Input 1, Disabling (HA)		
Response at the beginning of disabling (HA)	<p>no reaction</p> <p>reaction as with rising edge</p> <p>reaction as with falling edge</p> <p>transmit current input state</p>	<p>This parameter defines the reaction taking place at the beginning of disabling.</p> <p>No reaction</p> <p>The value parameterized for the rising edge will be transmitted.</p> <p>Only if "Transmit value = on rising edge (push button as n.o. contact)" and "Transmit value = on rising and falling edge (switch)".</p> <p>The value parameterized for the falling edge will be transmitted.</p> <p>Only if "Transmit value = on falling edge (push button as n.c. contact)" and "Transmit value = on rising and falling edge (switch)".</p> <p>The current state of the inputs corresponding to the parameterization for rising and falling edge will be transmitted.</p> <p>Only if "Transmit value = on rising and falling edge (switch)".</p>
Response at the end of disabling (HA)	<p>no reaction</p> <p>reaction as with rising edge</p> <p>reaction as with falling edge</p> <p>transmit current input state</p>	<p>This parameter defines the reaction taking place at the end of disabling.</p> <p>No reaction</p> <p>The value parameterized for the rising edge will be transmitted.</p> <p>Only if "Transmit value = on rising edge (push button as n.o. contact)" and "Transmit value = on rising and falling edge (switch)".</p> <p>The value parameterized for the falling edge will be transmitted.</p> <p>Only if "Transmit value = on falling edge (push button as n.c. contact)" and "Transmit value = on rising and falling edge (switch)".</p> <p>The current state of the inputs corresponding to the parameterization for rising and falling edge will be transmitted.</p> <p>Only if "Transmit value = on rising and falling edge (switch)".</p>

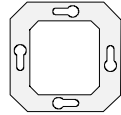

Function of input 1 = "Pulse counter"		
Count pulses at the input	on rising edge on falling edge on rising and falling edge	This parameter defines the edge for counting of pulses at the input.
Transmit interval time for count Base	2.1 s 4.2 s 8.4 s 17 s 34 s	Time base for interval time. When this time has elapsed, the count is transmitted to the bus and the counter reset for pulse counting in the next time interval. Time = Base · Factor
Transmit interval time for count Factor (3...127)	3 to 127, 30	Time factor for interval time. When this time has elapsed, the count is transmitted to the bus and the counter reset for pulse counting in the next time interval. Time = Base · Factor Presetting: 2.1 s · 30 = 63 s
Reset count and interval time by sync signal	no reset on rising edge on falling edge on rising and falling edge	This parameter defines the edge of the sync signal on which the count and the interval time are reset.
Telegram on reception of a sync signal	rising edge = ON, falling edge = --- rising edge = OFF, falling edge = --- rising edge = TOGGLE, falling edge = --- rising edge = ---, falling edge = ON rising edge = ---, falling edge = OFF rising edge = ---, falling edge = TOGGLE rising edge = ON, falling edge = OFF rising edge = OFF, falling edge = ON rising edge = TOGGLE, falling edge = TOGGLE rising edge = ---, falling edge = ---	On reception of a sync signal, switching telegrams can be transmitted to the bus independent of the sync signal edge. The output value is assigned to the edge. Important: This edge assignment is independent of the edge assignment for resetting the count of the counter and the interval time (parameter "Reset count and interval time by sync signal")
Input 1, Disabling (HA)		
		Disabling function not available

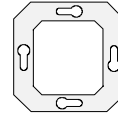

Function of input 1 = "Switching event counter"		
Count pulses at the input	on rising edge on falling edge on rising and falling edge	This parameter defines the edge for counting of pulses at the input.
Maximum count (1...65535)	1 to 65535, 65535	Maximum count at which the counter status is transmitted to the bus. After transmission, the counter is automatically reset internally.
Command on maximum count	no telegram ON OFF TOGGLE	Signal value transmitted to the bus on reaching of the maximum count.
Step width counter status output (1...255)	1 to 255, 255	Defines the step width (number of counting pulses) after which the current counter status is output.
Input 1, Disabling (HA)		
		Disabling function not available
Input 2 see input 1, however without "Pulse counter" (only sync input)		
Output 1 (only with "Function channel 1 = output")		
Mode	n.o. contact n.c. contact	Defines the mode of operation. The output works as an n.o. contact: ON → output supplying current OFF → output supplying no current The output works as an n.c. contact: ON → output supplying no current OFF → output supplying current
Response to bus voltage return	value before bus voltage failure close contact open contact	Defines the reaction of the switching output after bus voltage return.
Time function	none turn-on delay turn-off delay turn-on and turn-off delay timer function (without turn-on delay) timer function (with turn-on delay)	Selects the desired timer function.
Turn-on delay Factor (0..127)	0 to 127, 10	Defines the time factor for the turn-on delay. Time = Base · Factor

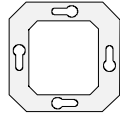

Ausgang 1 (Nur bei "Funktion Kanal 1 = Ausgang"!)		
Turn-on delay Base	130 ; 260; 520 ms 1.0; 2.1; 4.2; 8.4; 17; 34 s 1.1; 2.2; 4.5; 9; 18; 36 min 1.2 h	Defines the time base for the turn-on delay. Time = Base · Factor Presetting: 10 · 130 ms = 1.3 s
Turn-off delay Factor (0..127)	0 to 127, 10	Defines the time factor for the turn-off delay. Time = Base · Factor
Turn-off delay Base	130 ; 260; 520 ms 1.0; 2.1; 4.2; 8.4; 17; 34 s 1.1; 2.2; 4.5; 9; 18; 36 min 1.2 h	Defines the time base for the turn-off delay. Time = Base · Factor Presetting: 10 · 130 ms = 1.3 s
Turn-on and turn-off delay Base	130 ; 260; 520 ms 1.0; 2.1; 4.2; 8.4; 17; 34 s 1.1; 2.2; 4.5; 9; 18; 36 min 1.2 h	Defines the time base for the turn-on and the turn-off delay. Time = Base · Factor Presetting: 10 · 130 ms = 1.3 s
Reaction to OFF telegram	switch off ignore OFF telegram	Defines the reaction of the switching actuator on reception of an OFF telegram with active timer function.
Feedback	none non-inverted inverted	Defines whether and how feedbacking is effected via the feedback objects.
Additional function (HA)	none logic-operation object disabling object priority-position object	Defines whether additional function 1 is on or off.
Output 1, Logic operation (only with "Additional function = Logic-operation object") (HA)		
Logic operation (HA)	none OR AND AND with feedback	Defines the logic operation.
Output 1, Disabling (only with "Additional function = Disabling object") (HA)		
Disabling object polarity (HA)	enabled = 0, disabled = 1 enabled = 1, disabled = 0	Defines whether disabling is effected on reception of an ON or an OFF telegram.
Function at the beginning of disabling (HA)	no change switch off switch on	Defines the reaction of the switching output at the beginning of disabling via the disabling object.
Function at the end of disabling (HA)	no change switch off switch on	Defines the reaction of the switching output at the end of disabling via the disabling object.
Output 2 see output 1		